

# LG

***THERMA V***<sup>TM</sup>

Air-to-Water Heat Pump / Split Type  
R32 / 50Hz

5BPU0-03D (Replaces 5BPU0-03C)

# TOTAL HVAC SOLUTION PROVIDER

ENGINEERING PRODUCT DATA BOOK

***THERMA V***<sup>TM</sup>  
Split Type

**General Information**

**Indoor Unit**

**Hydro Box Unit**

**IWT Unit**

**Outdoor unit**

**Design and installation**

# ***THERMA V***<sup>TM</sup>



Split Type

## **General Information**

- 1. Model Line Up**
- 2. Nomenclature**

# 1. Model line up

## 1.1 Indoor Unit

Category	Type	External Appearance	Electric heater Capacity [kW]	Model Name	
				Heating Capacity * (kW)	
				9.0	
AWHP Split Type	Hydro Box Type		6.0	ZHNW09606A1 [HN091MR NK5]	
	IWT(Integrated Water Tank)		6.0	ZHNW20606I0 [HN0916T NB1]	

**Note**

\* : Actual system capacity would be different accordance with combination of outdoor unit.

## 1.2 Outdoor Unit

Category		Model Name		
		Heating Capacity (kW)		
		5.5	7.0	9.0
1 Phase Model 1 Ø, 220-240 V, 50 Hz		ZHUW056A0 [HU051MR U44]	ZHUW076A0 [HU071MR U44]	ZHUW096A0 [HU091MR U44]
Combination	ZHNW09606A1 [HN091MR NK5]	○	○	○
	ZHNW20606I0 [HN0916T NB1]	○	○	○
External Appearance				

## 2. Nomenclature

### 2.1 Indoor Unit

#### ■ Factory Model Name

Model Name	ZH	N	W	09	6	06	A	1
No.	1	2	3	4	5	6	7	8

No.	Signification
1	<b>Air-to-Water Heat Pump for R32</b>
2	<b>Classification</b> N : Indoor unit of Split type
3	<b>Model Type</b> W : Inverter Heat Pump
4	<b>Heating Capacity (kW) (for Hydro Box Type)</b> Ex) 9kW → '09' <b>Water Volume (ℓ) (for IWT)</b> Ex) 200ℓ → '20'
5	<b>Electrical ratings</b> 6 : 1Ø, 220-240V, 50 Hz
6	<b>Heater Capacity (kW)</b> Ex) 06kW → '06'
7	<b>Function</b> A : General heating heat pump I : Integrated water tank unit
8	<b>Serial number</b>

## 2. Nomenclature

### ■ Buyer Model Name

<b>Model Name</b>	<b>H</b>	<b>N</b>	<b>09</b>	<b>1</b>	<b>M</b>	<b>R</b>	<b>N</b>	<b>K</b>	<b>5</b>
No.	1	2	3	4	5	6	7	8	9

No.	Signification
1	<b>Air-to-Water Heat Pump</b>
2	<b>Classification</b> N : Indoor unit
3	<b>Heating Capacity (kW)</b> Ex) 9kW → '09'
4	<b>Electrical ratings</b> 1 : 1Ø, 220-240V, 50 Hz
5	<b>Leaving Water Combination</b> M : Mid Temperature T : DHW Tank Integrated unit
6	<b>Refrigerant</b> R : R32
7	<b>Classification</b> N : Indoor unit of Split type
8	<b>Platform (Chassis code)</b> K : K1 Chassis B: Integrated water tank Platform
9	<b>Serial number</b>

## 2. Nomenclature

### 2.2 Outdoor Unit

#### ■ Factory Model Name

Model Name	ZH	U	W	09	6	A	0
No.	1	2	3	4	5	6	7

No.	Signification
1	<b>Air-to-Water Heat Pump for R32</b>
2	<b>Classification</b> U : Outdoor unit of Split type
3	<b>Model Type</b> W : Inverter Heat Pump
4	<b>Heating Capacity (kW)</b> Ex) 9kW → '09'
5	<b>Electrical ratings</b> 6 : 1Ø, 220-240V, 50 Hz
6	<b>Function</b> A : General heating heat pump
7	<b>Serial number</b>

## 2. Nomenclature

### ■ Buyer Model Name

<b>Model Name</b>	<b>H</b>	<b>U</b>	<b>09</b>	<b>1</b>	<b>M</b>	<b>R</b>	<b>.</b>	<b>U</b>	<b>4</b>	<b>4</b>
No.	1	2	3	4	5	6		7	8	9

No.	Signification
1	<b>Air-to-Water Heat Pump</b>
2	<b>Classification</b> U : Outdoor unit of Split type
3	<b>Heating Capacity (kW)</b> Ex) 9kW : '09'
4	<b>Electrical ratings</b> 1 : 1Ø, 220-240V, 50 Hz
5	<b>Leaving Water Combination</b> M : Mid Temperature
6	<b>Type of Refrigerant</b> R : R32
7	<b>Classification</b> U : Outdoor unit of Split type
8	<b>Platform (Chassis code)</b> 4 : U36A Chassis
9	<b>Serial number</b>



***THERMA V***<sup>TM</sup>  
Split Type

**Indoor Unit**

**Hydro Box Unit**

**IWT Unit**

# ***THERMA V***<sup>TM</sup>

Split Type

## **Hydro Box Unit**

- 1. List of Functions**
- 2. Specification**
- 3. Dimensions**
- 4. Wiring Diagram**
- 5. Piping Diagram**
- 6. Hydraulic Performance**
- 7. Sound Levels**

# 1. List of Functions

## ■ Basic functions of Unit

Category	Functions	ZHNW09606A1 [HN091MR NK5]
Installation	Electric heater (Operation)	O
Reliability	Self diagnosis	O
Convenience	Auto Restart	O
	Child lock	O
	Sleep mode	O
	Timer (on/off)	O
	Timer (weekly)	O
	Two thermistor control	X
Network function	Network solution(LGAP)	O (Accessory)
	Modbus connectivity (without gateway)	O
Air to Water Heat Pump Functions	Anti-condensation on floor (cooling)	O
	Digital output for external pump	O
	Current flow rate monitoring	O
	Thermostat interface (230V AC)	O
	Thermostat interface (24V AC)	X
	Solar thermal system	O (Accessory)
	DHW(Domestic Hot Water) heating	O (Accessory)
	PHEX anti-freezing control	O
	Water pump anti-stuck function	O
	Weather compensation for heating and cooling (Auto mode)	O
	Low noise operation	O
	Anti-overheating of water pipe	O
	Emergency operation	O
	Weather Dependent Operation with Thermostat	O
	Scheduler (DHW Tank Heater)	O
	Timer (Domestic Hot Water Tank Heater)	O
	Quick Domestic Hot Water Tank Heating	O
	Screed Drying Mode	O
	Base Pan Heating	O
	External input and output control(CN-EXT)	O
	Water flow control	O
	Water pressure monitoring	O
	Digital input for energy saving (ESS)	O
	Energy Monitoring	O
	DHW Recirculation	O

**Note**

1. O : Applied, X : Not applied

Accessory : Ordered and purchased separately the accessory package referring to the model name provided and install at field.  
Accessory line-ups varies by region, so check your local catalogue or local sales material.

# 1. List of Functions

## ■ Accessory Compatibility List

Category	Product	Remark	ZHNW09606A1 [HN091MR NK5]	
WiredRemoteC ontroller	Standard	PREMTW101	New standard (White)	O
Dry Contact	Simple Contact	PDRYCB000	Simple Dry Contact	O
	Communication Type	PDRYCB400	2 Points Dry Contact (For Setback)	X
		PDRYCB320	For 3rd party Thermostat	O
		PDRZCB500	Dry Contact for Modbus	X
ETC	Remote temperature sensor	PQRSTA0	-	O
	Group control wire	PZCWRCG3	0.25 m	X
	2-Remo Control Wire	PZCWRC2	0.25 m	O
	Extension wire	PZCWRC1	10 m	O
	Wi-Fi controller *	PWFMD200	USB Cable : 0.6 m	O
			Extension cable : 0.5 m	
	Wi-Fi Extension cable	PWYREW000	USB Extension cable : 10 m	O
	Meter Interface Module***	PENKTH000	Interface between IDU and Meter	O
2 Zone Valve Controller	PZNVVB200	-	O	
Accessory Kit for AWHP	DHW tanks (Single coil)	OSHW-200F	200 L	O
		OSHW-300F	300 L	O
		OSHW-500F	500 L	O
	DHW tanks (Double coil)	OSHW-300FD	300 L	O
	DHW tank kit	PHLTA	For Split (1Φ)	O
		PHLTB	For Monobloc	X
		PHLTC	For Split (3Φ)	X
	DHW sensor	PHRSTA0	included in PHLTA kit	O
	Mixing Valve	OSHA-MV	3/4" DN20	O
		OSHA-MV1	1" DN25	O
	3way valve	OSHA-3V	-	O
	Solar thermal kit	PHLLA	For hydro box unit	X
	2nd Circuit Thermistor	PRSTAT5K10	-	O
	Backup heater	AHEH036A [HA031M E1]	220-240 V, 1Φ, For monobloc	X
		AHEH066A [HA061M E1]	220-240 V, 1Φ, For monobloc	X
		AHEH068A [HA063M E1]	380-415 V, 3Φ, For monobloc	X
	Drain heater	PHDPC	For hydro box unit	O
Cover plate	PDC-HK10	For Split, IWT	O	
Buffer Tank (40ℓ)	OSHB-40KT	For IWT(integrable)	X	
DHW expansion vessel (8ℓ)	OSHE-12KT	For IWT (integrable)	X	

**Note**

1. O: Possible, X: Impossible, -: Not applicable, Embedded : Included with product.
2. \* : Some advanced functions controlled by individual controller cannot be operated.
3. \*\* : It could not be operated some functions.
4. \*\*\* Meter interface cannot be connected at the same time with 3rd-party controller.
5. If you need more detail, please refer to the **BECON** PDB or the manual of product. (<http://partner.lge.com/global> : Home> Doc.Library> Product > Control(BECON))

## 2. Specifications

Indoor Unit				ZHNW09606A1 [HN091MR NK5]
Operation Range (Leaving Water Temperature)	Cooling	Min. ~ Max.	°C DB	5 ~ 27
	Heating	Min. ~ Max.	°C DB	15 ~ 65
	DHW *	Min. ~ Max.	°C DB	15 ~ 80
Water Pump	Type			Canned type for hot water circulation
	Model			GRUNDFOS UPM3K 20-75 CHBL
	Motor Type			BLDC
	Steps of Pump Performance			Variable capacity 10% to 100%
	Power input	Min. ~ Max.	W	3 ~ 60
Heat Exchanger	Type			Brazed Plate HEX
	Quantity			1
	Number of Plate			EA 52
	Water Volume			ℓ 0.7
Flow Sensor	Type			Vortex
	Model			SIKA VVX20
	Measuring Range	Min. ~ Max.	ℓ/min	5 ~ 80
	Flow (Trigger point)	Min.	ℓ/min	7
Water Pressure Sensor	Model			Sensata OFM (2HMP)
	Measuring Range	Min. ~ Max.	bar(G)	0 ~ 20
Expansion Vessel	Volume	Max.	ℓ	8
	Water pressure	Max.	bar	3
	Water pressure	Pre-charged	bar	1
Strainer	Mesh size			mesh 30
	Material			Stainless Steel
Safety valve	Pressure Limit	Upper Limit	bar	3.0
Piping Connections	Water Circuit	Inlet	mm(Inch)	Male PT 25.4(1)
		Outlet	mm(Inch)	Male PT 25.4(1)
	Refrigerant Circuit	Gas	mm(Inch)	Φ 15.88 (5/8)
		Liquid	mm(Inch)	Φ 9.52 (3/8)
Wiring Connections	Power and Communication Cable (H07RN-F) (included Earth)		mm <sup>2</sup> x cores	0.75 x 4C
Sound Power Level	Heating	Rated	dB(A)	44
Dimensions	Net	W × H × D	mm	490 × 850 × 315
	Shipping	W × H × D	mm	563 × 1,082 × 375
Weight	Net			kg 37.6
	Shipping			kg 43.6
Exterior	Color			Nobel White
	RAL Code			RAL 9016
Electric Heater	Type			Sheath
	Number of Heating Coil			EA 2
	Capacity Combination			kW 3.0 + 3.0
	Operation			Automatic
	Heating Steps			Step 2
	Power Supply			V, Ø, Hz 220-240, 1, 50
	Rated Current			A 25.0
	Power Cable (H07RN-F) (Included Earth)			mm <sup>2</sup> x cores 4.0 x 3C

**Note**

1. Due to our policy of innovation some specifications may be changed without notification.
2. Wiring cable size must comply with the applicable local and national code. And "Electric characteristics" chapter should be considered for electrical work and design. Especially the power cable and circuit breaker should be selected in accordance with that.
3. Sound power level is measured on the rated condition in according with ISO 9614 standard. Therefore, these values can be increased owing to ambient conditions during operation.
4. \* DHW 58~80°C operating is available only when the booster heater is operating.

### 3. Dimensions

#### 3.1 Internal

##### ◆ ZHNW09606A1 [HN091MR NK5]

**Note**  
 1. Unit should be installed in compliance with the installation manual in the product box.  
 2. Unit should be grounded in accordance with the local regulations or applicable national codes.  
 3. All electrical components and terminals to be supplied from the site must comply with the local regulations or international codes.

[Unit: mm]  
 Chassis : K1  
 P/No. : TBZ37614404\_rev.01

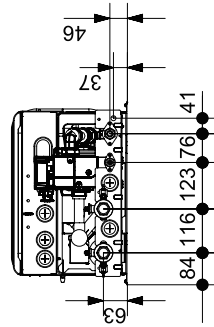
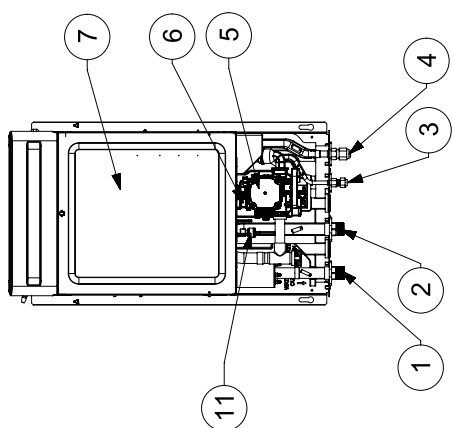
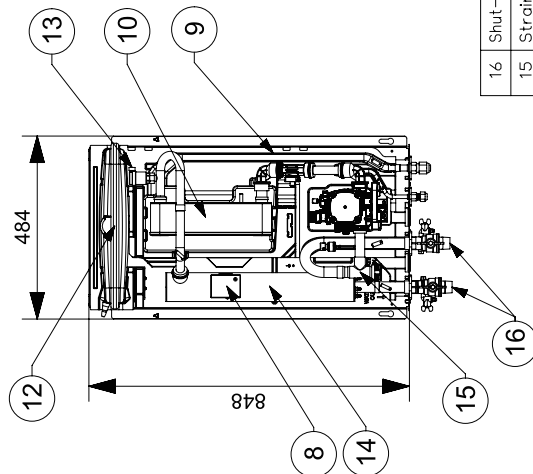
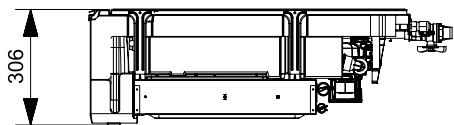

16	Shut-off valve (Included)	To drain or to block water when connecting pipe
15	Strainer	Filtering and stacking particles inside circulating water
14	Backup Heater	6 kW
13	Air Vent	Air purging when charging water
12	Expansion Tank	Absorbing Volume change of heated water
11	Water Pressure Sensor	SENSATA 2HMP3-04W 0-2MPa
10	Plate Heat Exchanger	Heat exchange between refrigerant and water
9	Flow Sensor	SIKA VVX20 5-80 LPM
8	Thermostat	Cut-off power input to electric heater at 90°C
7	Control Box	PCB and terminal blocks
6	Safety Valve	Open at water pressure 3 bar
5	Water Pump	GRUNDFOS UPM3K 20-75 CHBL
4	Refrigerant Pipe	∅ 15.88 mm
3	Refrigerant Pipe	∅ 9.52 mm
2	Entering Water Pipe	Male PT 1 Inch
1	Leaving Water Pipe	Male PT 1 inch
No.	Part Name	Description

### 3. Dimensions

#### 3.2 External

◆ ZHNW09606A1 [HN091MR NK5]

[Unit: mm]  
 Chassis : K1  
 P/No. : TBZ37614404\_rev.01

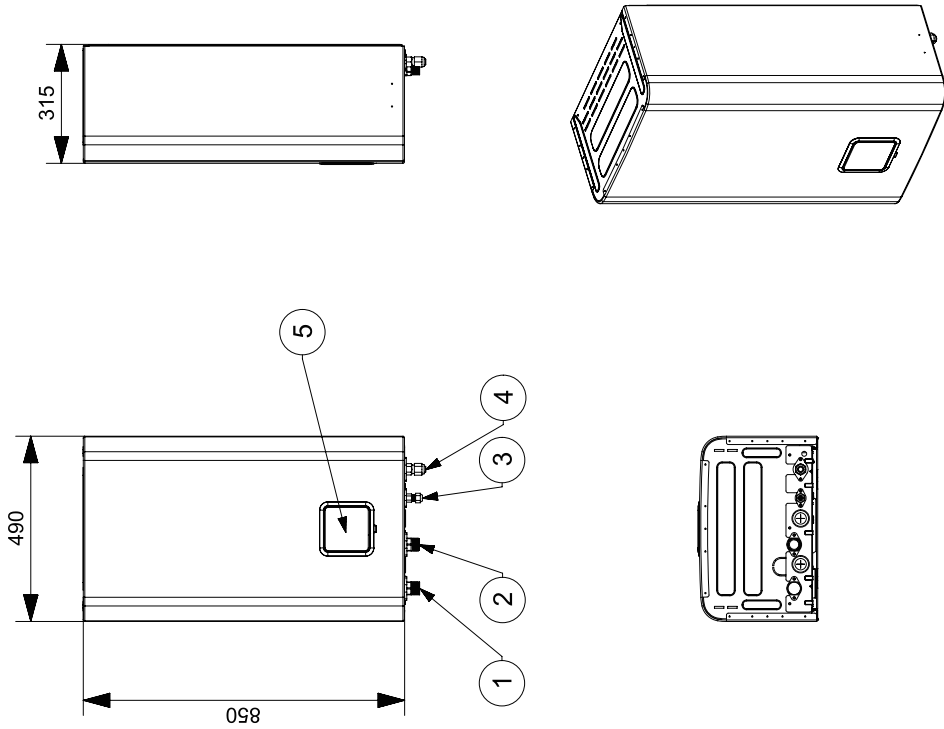

**Note**  
 1. Unit should be installed in compliance with the installation manual in the product box.  
 2. Unit should be grounded in accordance with the local regulations or applicable national codes.  
 3. Electrical components and materials to be supplied from the site must comply with the local regulations or international codes.

No.	Part Name	Description
5	Control Panel	Built-in Remote Controller
4	Refrigerant Pipe	Ø 15.88 mm
3	Refrigerant Pipe	Ø 9.52 mm
2	Entering Water Pipe	Male PT 1 inch
1	Leaving Water Pipe	Male PT 1 inch





# 5. Piping Diagram

## ZHNW09606A1 [HN091MR NK5]

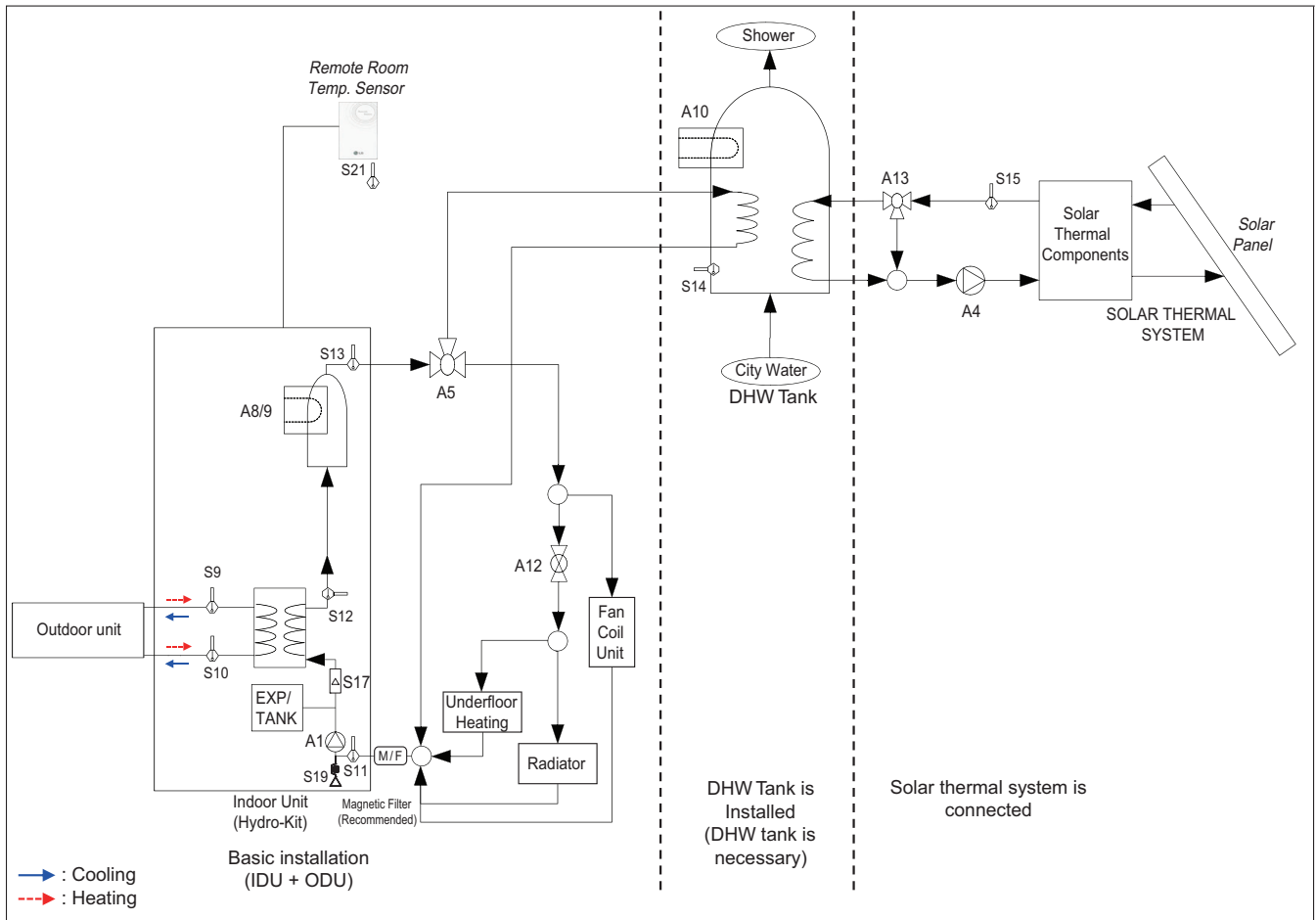

## 5. Piping Diagram

Category	Symbol	Meaning	PCB Connector	Remarks
Indoor unit / Main circuit	S9	Refrigerant temperature sensor (Gas side)	CN_PIPE_OUT	- NTC5kOhm
	S10	Refrigerant temperature sensor (Liquid side)	CN_PIPE_IN	- NTC5kOhm
	S11	Entering water temperature sensor	CN_TH3 (WATER IN)	- NTC5kOhm - S11,S12 and S13 are connected at 6-pin-type connector CN_TH3
	S12	Leaving water temperature sensor	CN_TH3 (PHEX OUT)	
	S13	Electric heater outlet temperature sensor	CN_TH3 (HEATER OUT)	
	S17	Flow Sensor	CN_F_SENSOR	- to monitor water flow rate
	S19	Entering Water Pressure sensor	CN_H2O_PRESS	- to monitor water pressure
	S20	Reserved	TB_SENSOR (AMBIENT)	
	S21	Remote room air sensor (Direct circuit)	CN_ROOM1	- Accessory: PQRSTA0 - NTC10kOhm
	A1	Internal water pump	CN_PUMP_A1 CN_MOTOR1	- Power is supplied via CN_PUMP_A1 - PWM signal is supplied via CN_MOTOR1
	A2	External pump	TB_EXT (PUMP A2)	- voltage-free contact - External water pump if head of internal pump is not sufficient or if parallel buffer tank is used
	A8 / A9	Backup heater (2 steps)	Coil 1: CN_L1, CN_N1 Coil 2: CN_L2, CN_N2 on HEATER-PCB	- Operating power(230 V AC 50 Hz) is supplied by external power source via Terminal block
	A12	2-way valve to block underfloor circuit from cooling water	CN_2WAY_A	- 3rd party accessory and Field installation (sold separately) - 2-wire NO- or NC-type 2-way valve is supported.
	EXP/TANK	Expansion vessel	-	- Absorbs volume change of heating water
	CTR/PNL	Control panel / Remote controller	CN_REMO	
M/F	Magnetic filter	-	- 3rd party accessory and Field installation (sold separately) - It is strongly recommended to install an additional filter on the heating water circuit.	

## 5. Piping Diagram

Domestic hot water circuit	S14	DHW tank temperature	CN_TH4 (BOOST)	- S14 is connected at 4-pin-type connector CN_TH4 - Accessory: PHRSTA0 - S14 is a part of DHW tank kit (Model : PHLTA)
	A5	3-way valve for changing between heating(cooling) and DHW tank	CN_3WAY_A	- 3rd party accessory and Field installation (sold separately) - SPDT type 3way valve is supported.
	A10	DHW boost heater	CN_TANK_HEATER	- 3rd party accessory and Field installation (sold separately) - Operating power (230 V AC 50 Hz) is supplied by external power source via Terminal block - Accessory: PHLTA (Relay, harness and DHW sensor)
	W/TANK	Domestic hot water tank	-	- Accessory (OSHW-series) or third-party tank suitable for heat pumps
	A15	Reserved	CN_PUMP A15	
	S23	Reserved	CN_RECIRC	
Solarthermal circuit	S15	Solar collector sensor	TB_SENSOR (SOLAR)	- 3rd party accessory and Field installation (sold separately) - PT1000
	S16	Reserved	CN_TH4 (SOLAR)	-for solar collector sensor use S15
	A4	Solar collector pump	CN_PUMP_A4	- 3rd party accessory and Field installation (sold separately)
	A13	3way-valve Solar	CN_3WAY_B	- 3rd party accessory and Field installation (sold separately) - SPDT type 3way valve is supported.
	Solarthermal system	Solarthermal equipment such as collector, solar pump, PT1000 sensor, solar heat-exchanger	-	- 3rd party accessory and Field installation (sold separately)

## 6. Hydraulic Performance

The water pump is variable type which is capable to change flow rate, so it may be required to change default water pump capacity in case of noise by water flow. In most case, however, it is strongly recommended to set capacity as Maximum.

### ■ Pressure Drop

Capacity [kW]	Rated flow-rate [LPM]	Pump Head [m] (at rated flow-rate)	Product pressure drop [m] (Plate heat exchanger)	Serviceable Head [m]	Min.flow-rate [LPM] (Recommend)
5	15.8	7.5	0.2	7.3	15
7	20.1	7.3	0.3	7.0	
9	25.9	6.1	0.4	5.7	

### Note

- To secure enough water flow rate, do not set water pump capacity as Minimum. It can lead unexpected flow rate error CH14.
- When installing the product, install additional pump in consideration of the pressure loss and pump performance.
- If flow-rate is low, overloading of product can occur.

### Q-H Chart

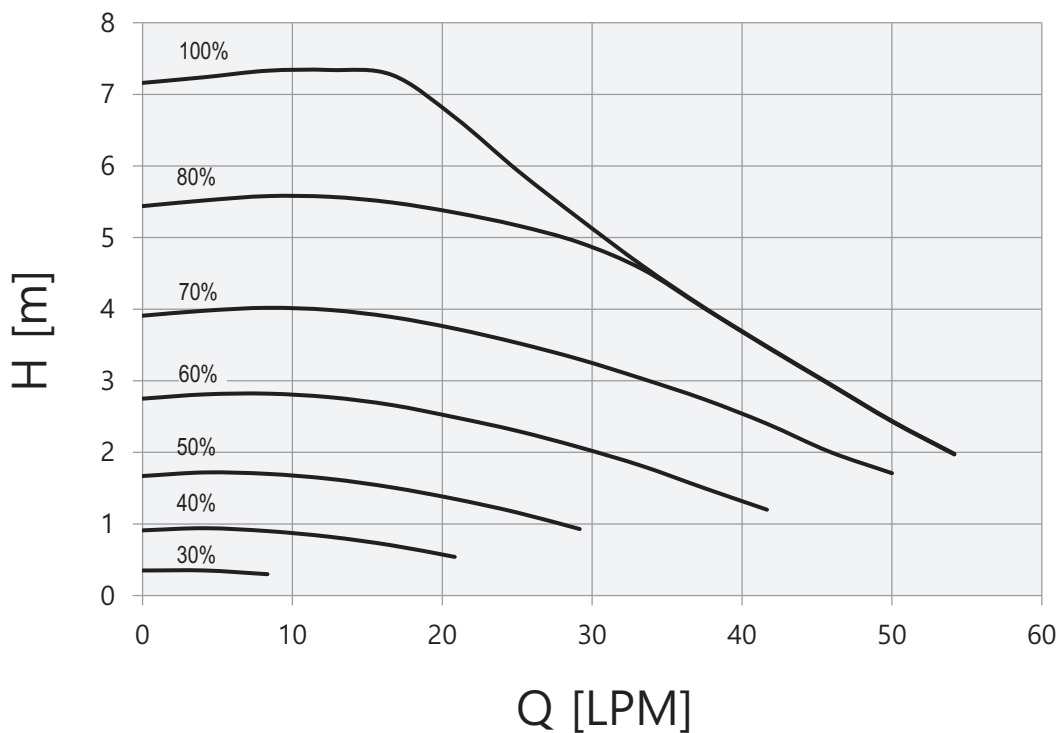

### Note

Performance test based on standard ISO 9906 with pre-pressure 2.0bar and liquid temperature 20°C.

## 7. Sound levels

### ■ Sound Power Level

#### Note

1. Data is valid at diffuse field condition.
2. Reference acoustic intensity  $0\text{dB} = 10\text{E-}6\mu\text{W/m}^2$
3. Sound power level is measured on the rated condition in the reverberation rooms. Refer to the Model Specifications for nominal conditions(Power source and Ambient temperature, etc)
4. Sound levels can be increased in accordance with installation and operating conditions.
5. Sound level will vary depending on a range of factors such as the construction (acoustic absorption coefficient) of particular installed place in which the equipment in installed.
6. Sound power level is measured on the rated condition in accordance with ISO 9614 standard. Therefore, these values can be increased owing to ambient conditions during operation.

Model	Sound Power Level [dB(A)]
ZHNW09606A1 [HN091MR NK5]	44

#### ZHNW09606A1 [HN091MR NK5]

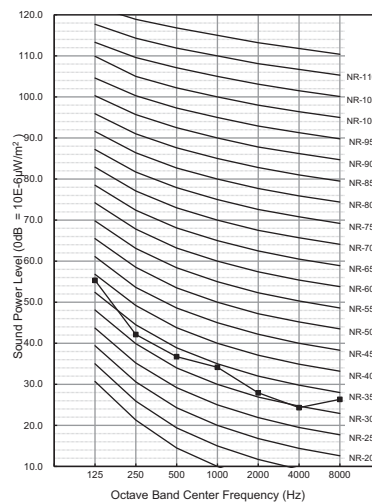

# ***THERMA V***<sup>TM</sup>

Split Type

## **IWT Unit**

- 1. List of functions**
- 2. Specification**
- 3. Dimensions**
- 4. Wiring Diagrams**
- 5. Piping Diagrams**
- 6. Hydraulic Performance**

# 1. List of Functions

## ◆ List of functions

Category	Functions	ZHNW2060610 [HN0916T NB1]
Installation	Electric heater	O
	Domestic Hot Water Tank heater*	X
	Screed Drying Mode	O
Reliability	Self diagnosis	O
Convenience	Auto Restart operation	O
	Child lock	O
	Sleep mode	O
	Timer (on/off)	O
	Timer (weekly)	O
	Remote room temperature sensing	O
Special function	Outdoor Temperature sensing	O
	Zone control (2 heating circuits)	O
	Zone control (max. 4 heating circuits)	X
	Wi-Fi control	O
	Group control	X
	2-Remo control	O
	External controller (CN-EXT)	O
Water Circuit Control	Thermostat Interface (230V AC)	O
	Thermostat Interface (24V AC)	X
	Water Pump ON / OFF Control	O
	Water Pump Forced Operation	O
	Current flow rate monitoring	O
	Solar-Thermal system	X
	Anti-Condensation on floor (cooling)	O
	PHEX Anti-Freezing Control	O
	Anti-overheating of Water Pipe	O
	Emergency Operation	O
	Seasonal auto mode	O
	Low Noise Operation	O
	Scheduler	O
	Timer	O
	Quick Domestic Hot Water Tank Heating	O
	Electric heater capacity control by wiring	O
	Dry Contact	O
Remote Controller Supply	Wired Remote Controller	O
	Wireless Remote Controller	X

**Note**

1. O : Applied, X : Not applied
2. Some functions can be limited by remote controller.
3. \*:Tank can be heated by Electric heater

# 1. List of Functions

## ■ Accessory Compatibility List

Category		Product	Remark	ZHNW2060610 [HN0916T NB1]
Wired Remote Controller	Standard	PREMTW101	New standard (White)	O
	Simple Contact	PDRYCB000	Simple Dry Contact	O
Dry Contact	Communication Type	PDRYCB400	2 Points Dry Contact (For Setback)	X
		PDRYCB320	For 3rd party Thermostat	O
		PDRYCB500	Dry Contact for Modbus	X
ETC	Remote temperature sensor	PQRSTA0	-	O
	Group control wire	PZCWRCG3	0.25 m	X
	2-Remo Control Wire	PZCWRC2	0.25 m	O
	Extension wire	PZCWRC1	10 m	O
	Wi-Fi controller *	PWFMDD200	USB Cable : 0.6 m Extension cable : 0.5 m	O
	Wi-Fi Extension cable	PWYREW000	USB Extension cable : 10 m	O
	Meter Interface***	PENKTH000	Interface between IDU and Meter	O
	2 Zone Valve Controller	PZNVVB200	-	O
Accessory Kit for AWHP	Mixing valve	OSHA-MV	3/4" DN20	O
		OSHA-MV1	1" DN25	O
	3way valve	OSHA-3V	-	X
	Solar thermal kit	PHLLA	For hydro box	X
	2nd Circuit Thermistor	PRSTAT5K10	-	O
	Backup heater	AHEH036A [HA031M E1]	220-240 V, 1Φ For Monobloc	X
		AHEH066A [HA061M E1]	220-240 V, 1Φ For Monobloc	X
		AHEH068A [HA063M E1]	380-415 V, 3Φ For Monobloc	X
	Drain pan	PHDPB	For hydro box unit	X
	Cover plate	PDC-HK10	For Split, IWT	O
	Buffer Tank (40ℓ)	OSHB-40KT	For IWT (integrable)	O
	DHW expansion vessel (8ℓ)	OSHE-12KT	For IWT (integrable)	O

**Note**

1. O: Possible, X: Impossible, - : Not applicable, Embedded : Included with product.
2. \* : Some advanced functions controlled by individual controller cannot be operated.
3. \*\* : It could not be operated some functions.
4. \*\*\* Meter interface cannot be connected at the same time with 3rd-party controller.
5. If you need more detail, please refer to the **BECON** PDB or the manual of product. (<http://partner.lge.com/global> : Home> Doc.Library> Product > Control(BECON))



## 2. Specifications

### ◆ Technical Specifications

Indoor Unit Model Name			ZHNW2060610 [HN0916T NB1]	
Operation Range (Leaving Water)	Cooling (Min.~Max.)		°C	5 ~ 27
	Heating (Min.~Max.)		°C	15 ~ 65
	Domestic Hot Water (Min.~Max.)*		°C	15 ~ 80
DHW Tank	Type		-	Hydro module with integrated hot water tank
	Material		-	Enameled steel
	Water Volume		ℓ	200
	Internal Thermal Protect limit		°C	85
	Rated pressure (Pressure limit)		bar	10
	Insulation	Material		-
Thickness		mm	50	
Heat loss (for 24hr)		kWh	1.46	
Buffer Tank (Accessory)	Water Volume		ℓ	40
	Material		-	P235GH steel (DIN EN 10028 - 2)
	Insulation Material		-	Closed cell foamed rubber
	Dimensions(W x H x D)		mm	518 x 560 x 175
	Weight		kg	24
Main water pump	Type		-	Canned type for hot water circulation
	Model		-	WILO Para KU 25-130/8-75/12 iPWM1
	Motor type		-	BLDC
	Steps of Pump Performance		-	Variable speed 10% to 100%
	Power input		W	7.5 ~ 75
	Max. Head		m	7.7
DHW water Pump	Model		-	WILO ZRS 15/6-3 KU
	Steps of Speed		step	3
	Power input		W	45 ~ 85
	Max. Head		m	5.7
Expansion vessel	Water Volume		ℓ	12
	Factory pre-charge		bar	0.75
	Max.pressure		bar	3
DHW Expansion vessel (Accessory)	Water Volume		ℓ	8
	Factory pre-charge		bar	3
	Max. pressure		bar	10
	Weight		kg	2.5
Heat Exchanger (Refrigerant ↔ Water)	Type		-	Brazed Plate HEX
	Number of Plates		EA	24
Heat Exchanger (Water ↔ DHW)	Type		-	Brazed Plate HEX
	Number of Plates		EA	26
3 Way Valve	Flow coefficient		K <sub>vs</sub>	8
Safety Valve	Pressure Limit		Upper Limit	bar
DHW Safety valve	Pressure Limit		Upper Limit	bar
Flow Sensor	Model		-	SIKA VVXC9SNBUC00252P
	Measuring range		Min. ~ Max.	ℓ/min
	Flow(Trigger point)		Min.	ℓ/min
Strainer	Type		-	Intergrated to valve
	Mesh size		mesh	42.3 (0.6mm)
DHW Strainer	Mesh size		mesh	50.8 (0.5 mm)
Wiring Connections	Power and Communication Cable (H07RN-F) (included Earth)		mm <sup>2</sup> x cores	0.75 x 4C
Piping Connections	Refrigerant Circuit	Gas	mm(inch)	∅ 15.88 (5/8)
		Liquid	mm(inch)	∅ 9.52 (3/8)
	Water Circuit	Inlet	mm(inch)	Female ∅ 22 (G1")
		Outlet	mm(inch)	Female ∅ 22 (G1")
	DHW Tank Water Circuit	Cold Inlet	mm(inch)	Female ∅ 19.75 (G3/4")
		Hot Outlet	mm(inch)	Female ∅ 19.75 (G3/4")
	Recirculation		mm(inch)	Female ∅ 19.75 (G3/4")
Sound Power Level			dB(A)	43
Dimensions (W × H × D)	Unit		mm	601 × 1,812 × 685
	Shipping		mm	640 × 2,050 × 790
Weight	Unit		kg	140
	Shipping		kg	152
Exterior	Color		-	Nobel White
	RAL Code		-	RAL 9016

**Note**

- \* : DHW 58~80°C operating is available only when the Electric heater is operating.
- Due to our policy of innovation some specifications may be changed without notification.
- Wiring cable size must comply with the applicable local and national codes and "Electric characteristics" chapter should be considered for electrical work and design.
- LWT : Leaving Water Temperature, OAT : Outdoor Air Temperature.
- Sound power level is measured on the rated condition in according with ISO 9614 standard. Therefore, these values can be increased owing to ambient conditions during operation.
- Performances are accordance with EN14511 and reflect ErP testing conditions. Above gives the declared values at rated conditions acc. ErP regulation.
- This product contains fluorinated greenhouse gases.

## 2. Specifications

### ◆ Electrical Specifications

Indoor Unit Model Name		ZHNW20606I0 [HN0916T NB1]	
Electric Heater (Case 1)	Power Supply	V, Ø, Hz	220-240, 1, 50
	Power Supply Cable (H07RN-F) (Included Earth)*	mm <sup>2</sup> x cores	4.0 x 3
	Power connection wiring**	-	L1,N,Earth
	Heater Type	-	Sheath
	Number of Heating Coil	EA	1
	Capacity Combination	kW	2.0
	Operation	-	Automatic
	Rated Current	A	8.7
	Maximum Current	A	11.1
	Fuses	A	16
Maximum electrical power***	kW	2.52	
Electric Heater (Case 2)	Power Supply	V, Ø, Hz	220-240, 1, 50
	Power Supply Cable (H07RN-F) (Included Earth)*	mm <sup>2</sup> x cores	4.0 x 3C
	Power connection wiring**	-	L1,N,Earth (needs connect Bridge to L2 from L1)
	Heater Type	-	Sheath
	Number of Heating Coil	EA	2
	Capacity Combination	kW	2.0 + 2.0
	Operation	-	Automatic
	Rated Current	A	17.4
	Maximum Current	A	19.9
	Fuses	A	20
Maximum electrical power***	kW	4.52	
Electric Heater (Case 3)	Power Supply	V, Ø, Hz	380-415, 3, 50
	Power Supply Cable (H07RN-F) (Included Earth)*	mm <sup>2</sup> x cores	4.0 x 5C
	Power connection wiring**	-	L1,L2,L3,N,Earth
	Heater Type	-	Sheath
	Number of Heating Coil	EA	3
	Capacity Combination	kW	2.0 + 2.0 + 2.0
	Operation	-	Automatic
	Rated Current	A	8.7
	Maximum Current	A	11.1
	Fuses	A	16 + 16 + 16
Maximum electrical power***	kW	6.52	

#### Note

- \* Wiring cable size must comply with the applicable local and national codes. And "Electric characteristics" chapter should be considered for electrical work and design. Especially the power cable and circuit breaker should be selected in accordance with that.
- \*\* The size of Electrical Heater and the Fuses depend on the choice of the connection power.
- \*\*\* Joint maximal load (circulation pumps, electronic valves ...) which can be connected to or powered by the internal unit, must not exceed the specified value. Higher consumed parts (i.e. pumps) should have their own supply.
4. The guideline about cable is taken into account laying B2 from the table A.52.4 – IEC 60364-5-52. The cable in the installation pipe is fixed to the wall.

### 3. Dimensions

#### 3.1 Internal

##### ◆ ZHNW2060610 [HN0916T NB1]

**Note**  
 1. Unit should be installed in compliance with the installation manual in the product box.  
 2. Unit should be grounded in accordance with the local regulations or applicable national codes.  
 3. All electrical components and materials to be supplied from the site must comply with the local regulations or international codes.

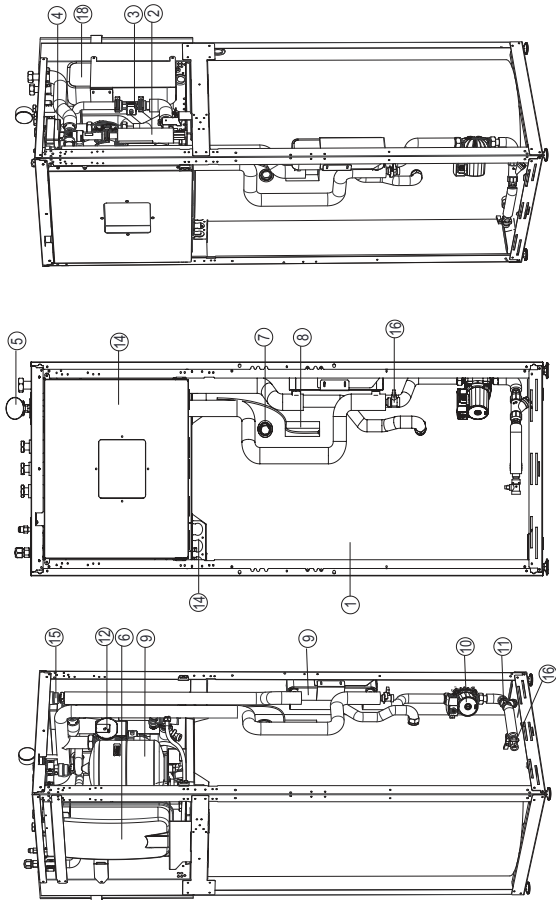

18	Heat exchanger	Plate-heat-exchanger (Ref./water)
17	Electrical Conduits	For Electric wiring
16	Drain cock	Valve for water draining
15	Air vent	Air purging when charging water
14	Control box	PCB and terminal blocks
13	Expansion vessel	8 L for DHW circuit (Accessory)
12	Water pump	Main circulation pump
11	DHW strainer	DHW Strainer
10	Water pump	DHW tank charging pump
9	Heat exchanger	Plate-heat-exchanger (Water/DHW)
8	DHW tank sensor	temperature sensor
7	Magnesium anode	To prevent corrosion
6	Expansion vessel	12 L for Heating circuit
5	Pressure gauge	Pressure gauge
4	3Way valve	3-way-valve (DHW / Heating)
3	Flow sensor	SIKA VVXC9SNBUC00252P
2	Heater	Electric Back-up heater(6 kW)
1	DHW Tank	Domestic hot water tank(200 L)
No.	Part Name	Description

[Unit:mm]  
 P/No : TBu37797501\_rev.03

### 3. Dimensions

#### 3.2 External

##### ◆ ZHNW2060610 [HN0916T NB1]

[Unit:mm]

P/No : TBJ37797501\_rev.03

**Note**  
 1. Unit should be installed in compliance with the installation manual in the product box.  
 2. Unit should be grounded in accordance with the local regulations or applicable national codes.  
 3. All electrical components and materials to be supplied from the site must comply with the local regulations or international codes.

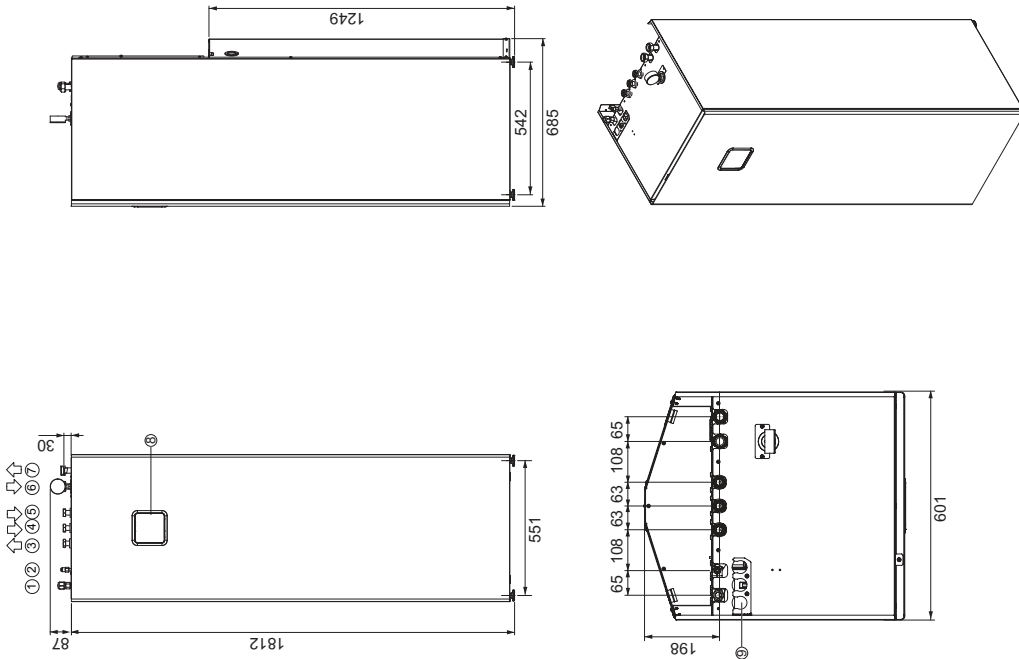

9	Control Panel	Built-in Remote controller
8	Electrical conduits	For Electric wiring
7	Heating circuit outlet pipe	Female G1"
6	Heating circuit inlet pipe	Female G1"
5	DHW Re-circulation pipe	Female G3/4"
4	Domestic cold water inlet pipe	Female G3/4"
3	Domestic hot water outlet pipe	Female G3/4"
2	Refrigerant liquid pipe	SAE 3/8"
1	Refrigerant gas pipe	SAE 5/8"
No.	Part Name	Description

# 4. Wiring diagrams

## ZHNW2060610 [HN0916T NB1]

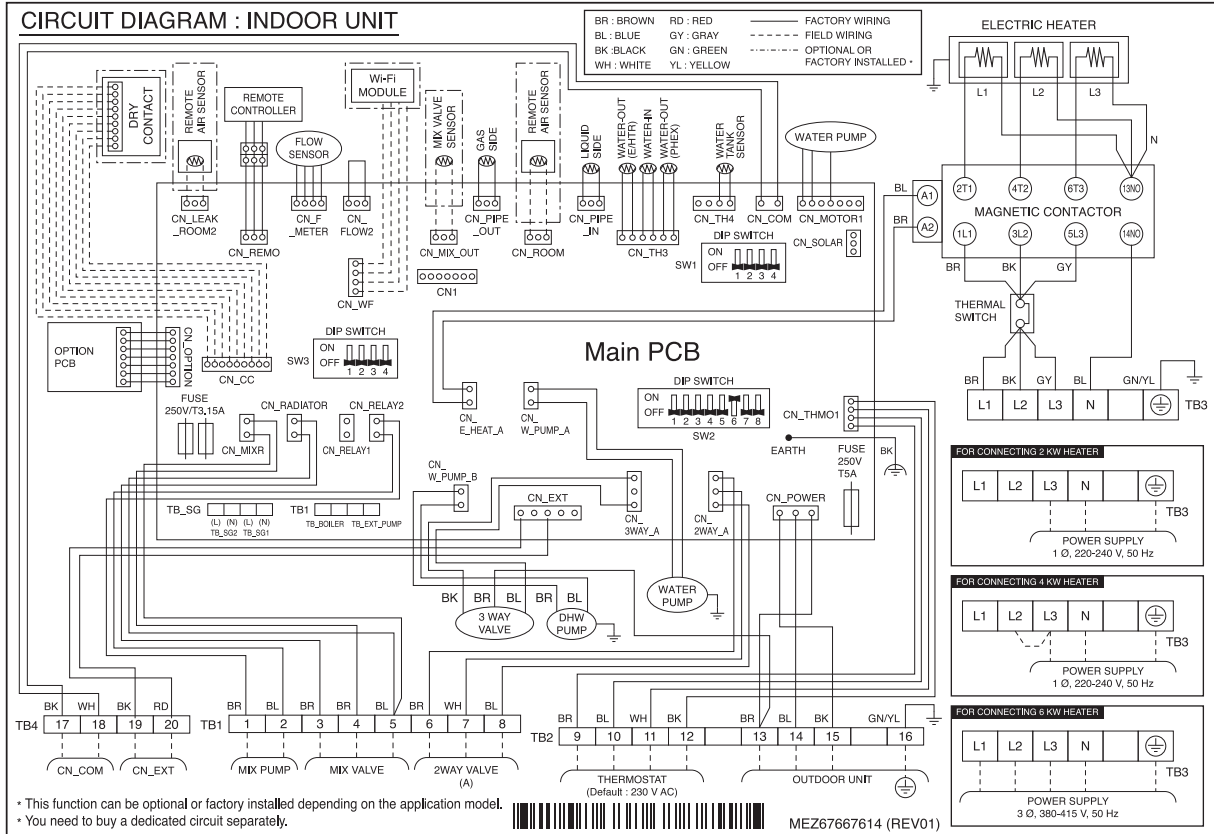

# 5. Piping diagrams

## ZHNW2060610 [HN0916T NB1]

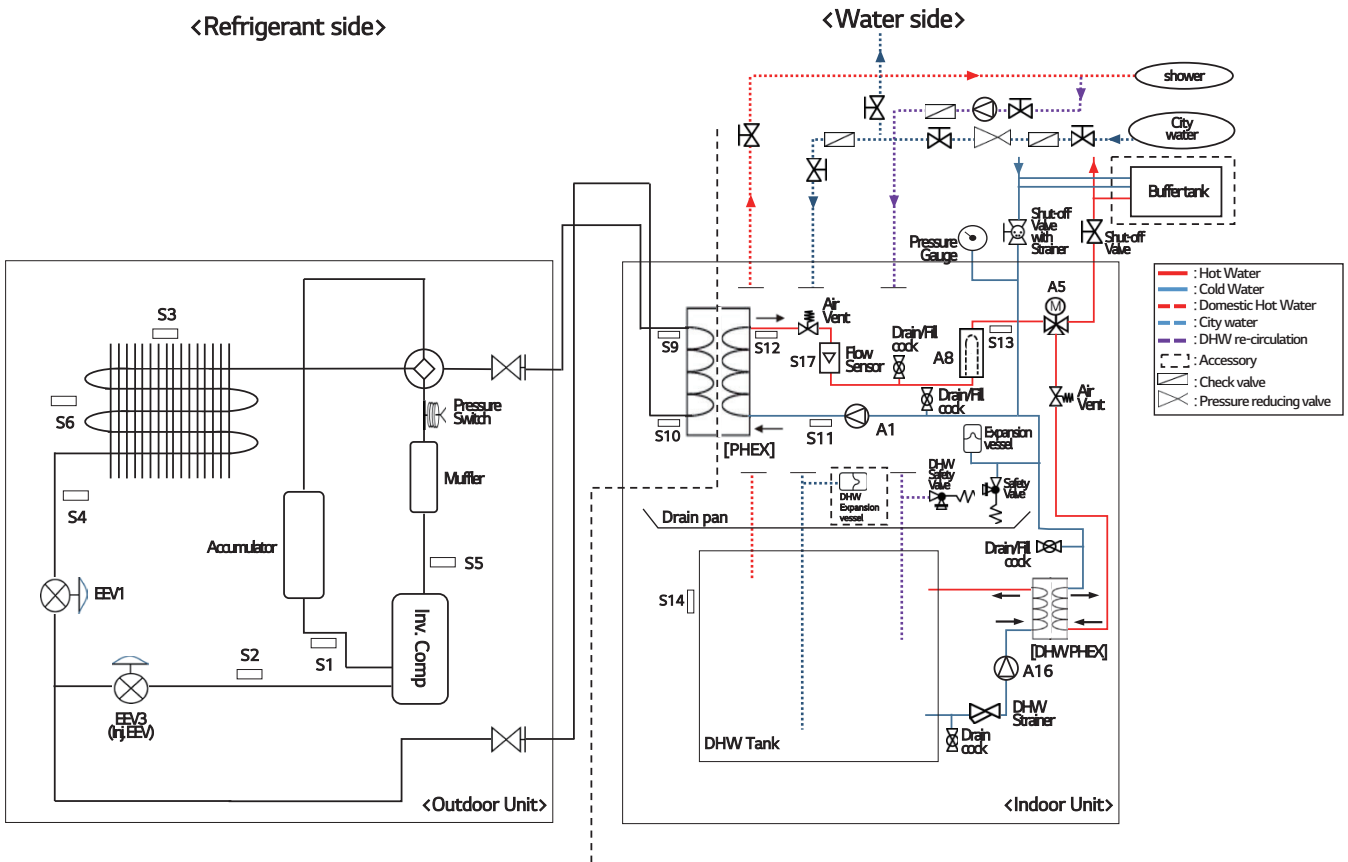

Category	Symbol	Meaning	PCB Connector
Refrigerant side	S1	Compressor-suction pipe temperature sensor	CN_SUCTION
	S2	Inlet IHEX temperature sensor	CN_VI_IN
	S3	Outdoor air temperature sensor	CN_AIR
	S4	Outdoor-HEX temp.sensor	CN_C_PIPE
	S5	Compressor-discharge pipe temperature sensor	CN_DISCHARGE
	S6	Outdoor-HEX middle temp.sensor	CN_MID
	S9	PHEX gas temp.sensor	CN_PIPE/OUT
	S10	PHEX liquid temp.sensor	CN_PIPE/IN
	EEV1	Electronic Expansion Valve (Heating)	CN_EEV1(WH)
EEV3	Electronic Expansion Valve (Injection)	CN_EEV1(YL)	
Water Side	S11	Inlet water temperature sensor	CN_TH3
	S12	Outlet water temperature sensor	
	S13	Electric heater outlet sensor	
	S14	DHW tank temperature sensor	CN_TH4
	S17	Flow sensor	CN_F_METER
	A1	Main water pump	CN_MOTOR1 CN_W_PUMP_A
	A16	DHW water pump	CN_W_PUMP_B
	A5	3Way Valve	CN_3WAY_A
A8	Electric backup heater	CN_E_HEAT_A	

## 6. Hydraulic Performance

The main water pump is variable type which is capable to change flow rate, so it may be required to change default water pump capacity in case of noise by water flow. In most case, however, it is strongly recommended to set capacity as Maximum.

### ■ Pressure Drop

Capacity [kW]	Rated flow-rate [LPM]	Pump Head [m]	Product pressure drop [m]	Serviceable Head [m]	Min.flow-rate [LPM] (Recommend)
5	15.8	8.2	1.13	7.1	15
7	20.1	7.8	1.78	6.0	
9	25.9	6.8	2.87	3.9	

### Note

- To secure enough water flow rate, do not set water pump capacity as Minimum. It can lead unexpected flow rate error CH14.
- When installing the product, install additional pump in consideration of the pressure loss and pump performance.
- If flow-rate is low, overloading of product can occur.
- Above data is valid at Rated flow rate with delta-temperature of 5 K

### ◆ Wilo PARA KU 25 -130/8 - 75/12 iPWM1

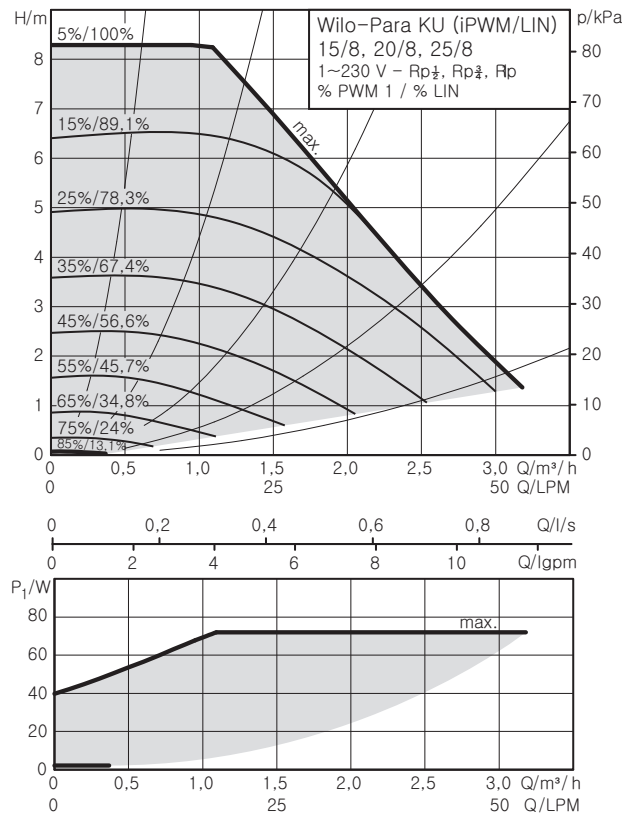

### Note

- Max. : high speed setting
- [Shaded Area]: Operation cutoff range
- To secure enough water flow rate, do not set water pump speed as "Min."

## 6. Hydraulic Performance

The DHW water pump is three speed-adjustable (Maximum / Medium / Minimum), but Minimum step is not used. It is recommended to use Maximum or Medium steps. In case of noise by water flow, it may be required to change default water pump speed. In most case, however, it is strongly recommended to set speed as Maximum.

### ■ Wilo ZRS 15/6-3 KU

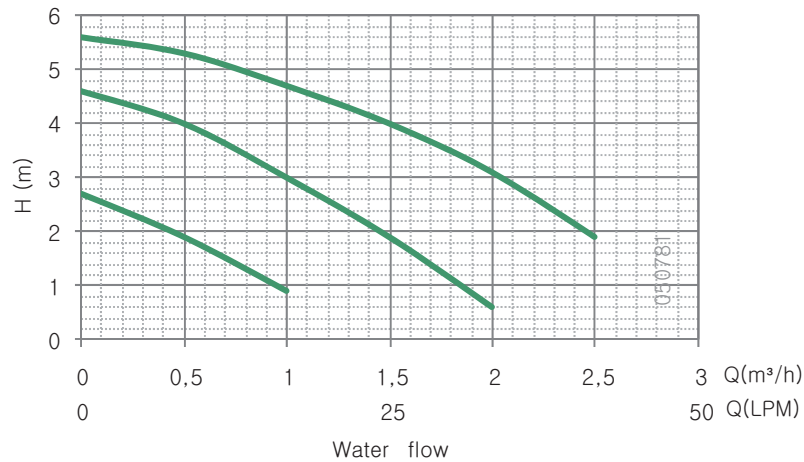

#### Note

Performance test based on standard ISO 9906 with pre-pressure 2.0bar and liquid temperature 20°C.

#### ⚠ WARNING

- Selecting a water flowrate outside the curves can cause damage to or malfunction of the unit.



# ***THERMA V***<sup>TM</sup>

## Split Type

### **Outdoor unit**

- 1. List of functions**
- 2. Specification**
- 3. Dimensions**
- 4. Wiring Diagram**
- 5. Piping Diagram**
- 6. Performance Data**
- 7. Operation Range**
- 8. Electric Characteristics**
- 9. Sound Levels**

# 1. List of functions

## Basic functions of Unit

Category	Functions	ZHUW056A0 [HU051MR U44] ZHUW076A0 [HU071MR U44] ZHUW096A0 [HU091MR U44]
Reliability	Defrost / Deicing	O
	High pressure switch	O
	Low pressure switch	X
	Phase protection	X
	Restart delay (3-minutes)	O
	Self diagnosis	O
	Soft start	X
Convenience	Test function	X
	Wiring Error Check	X
	Peak Control	O
	Mode Lock	O
	Low Noise Operation	O
	Forced Cooling Operation (Outdoor Unit)	X
	Base Pan Heater	O
Network function	Network solution(LGAP)	O

**Note**

1. O : Applied, X : Not applied

Accessory : Ordered and purchased separately the accessory package referring to the model name provided and install at field.  
Accessory line-ups varies by region, so check your local catalogue or local sales material.

## Accessory Compatibility List

Category	Product	Remark	ZHUW056A0 [HU051MR U44] ZHUW076A0 [HU071MR U44] ZHUW096A0 [HU091MR U44]	
Central Controller	AC EZ	PQCSZ250S0	AC EZ	X
	AC Ez Touch	PACEZA000	AC Ez Touch	O
	AC Smart	PACS4B000	AC Smart IV	O
		PACS5A000	AC Smart 5	O
	ACP	PACP4B000	ACP IV	O
		PACP5A000	ACP 5	O
	AC Manager **	PACM4B000	AC Manager IV	O
PACM5A000		AC Manager 5	O	
Cloud Gateway***	PWFMDDB200	Cloud Gateway	O	
Gateway	IDU PI485	PHNFP14A0	Connected with Indoor Units	X
		PSNFP14A0	Connected with Indoor Units	X
	ODU PI485	PP485A00T	PI 485 Gateway	O
		PP485B00K	Gateway for AWHP	X
	BACnet	PQNFB17C0	ACP BACnet	O
Lonworks	PLNWKB000	ACP Lonworks	O	
ETC	PDI	PPWRDB000	PDI Standard	O
		PQNUD1S40	PDI Premium	O
	ACS IO Module	PEXPMB000	-	X

**Note**

1. O: Possible, X: Impossible, - : Not applicable

2. \* : Some advanced functions controlled by individual controller cannot be operated.

3. \*\* : ACP or AC Smart is needed.

4. \*\*\* : Hydrobox unit only

5. If you need more detail, please refer to the manual of product.

(<http://partner.lge.com/global> : Home> Doc.Library> Product > Control(BECON))

## 2. Specifications

### 2.1 Nominal Capacity and Power Input

#### ■ Combination with Hydro Box type

Nominal Capacity and Nominal Input				Indoor unit	ZHNW09606A1 [HN091MR NK5]		
-	Condition	Outdoor Temp. (°C) DB / WB	Leaving Water Temp. (°C)	Outdoor Unit	ZHUW056A0 [HU051MR U44]	ZHUW076A0 [HU071MR U44]	ZHUW096A0 [HU091MR U44]
Capacity	Cooling	35 / 24	18	kW	5.50	7.00	9.00
		35 / 24	7	kW	5.50	7.00	9.00
	Heating	7 / 6	35	kW	5.50	7.00	9.00
		7 / 6	55	kW	5.50	5.50	5.50
Power Input	Cooling	2 / 1	35	kW	3.30	4.20	5.40
		35 / 24	18	kW	1.20	1.56	2.14
	Heating	35 / 24	7	kW	1.96	2.59	3.46
		7 / 6	35	kW	1.12	1.43	1.94
EER	Cooling	7 / 6	55	kW	2.04	2.04	2.04
		2 / 1	35	kW	0.94	1.20	1.54
	Heating	35 / 24	18	W/W	4.60	4.50	4.20
		35 / 24	7	W/W	2.80	2.70	2.60
COP	Heating	7 / 6	35	W/W	4.90	4.90	4.65
		7 / 6	55	W/W	2.70	2.70	2.70
		2 / 1	35	W/W	3.52	3.51	3.50
SCOP (Low temp. Average)*					4.65	4.65	4.65
SCOP (High temp. Average)*					3.23	3.23	3.23
Rated Water Flow Rate (at LWT 35°C)				LPM	15.81	20.12	25.87

Technical Specifications			Indoor unit	ZHNW09606A1 [HN091MR NK5]		
			Outdoor Unit	ZHUW056A0 [HU051MR U44]	ZHUW076A0 [HU071MR U44]	ZHUW096A0 [HU091MR U44]
Sound Power Level	Heating	Rated	dB(A)	60	60	60
		Low noise	dB(A)	58	58	58
Dimensions	Net	W × H × D	mm	950 × 834 × 330	950 × 834 × 330	950 × 834 × 330
	Shipping	W × H × D	mm	1,065 × 918 × 461	1,065 × 918 × 461	1,065 × 918 × 461
Weight	Net		kg	60.0	60.0	60.0
	Shipping		kg	65.0	65.0	65.0
Exterior	Color		-	Warm Gray	Warm Gray	Warm Gray
	RAL Code		-	RAL 7044	RAL 7044	RAL 7044

Electrical Specifications		Indoor unit	ZHNW09606A1 [HN091MR NK5]		
		Outdoor Unit	ZHUW056A0 [HU051MR U44]	ZHUW076A0 [HU071MR U44]	ZHUW096A0 [HU091MR U44]
Power Supply		V, Ø, Hz	220-240, 1, 50	220-240, 1, 50	220-240, 1, 50
Peak Control Running Current	Cooling	A	13.0	14.0	15.0
	Heating	A	13.0	14.0	15.0
Rated Running Current	Cooling	A	5.3	6.9	9.5
	Heating	A	5.0	6.3	8.6
Circuit breaker		A	16	20	25
Wiring Connections	Power Supply Cable (H07RN-F) (included Earth)	mm <sup>2</sup> x cores	4.0 x 3C	4.0 x 3C	4.0 x 3C

**Note**

1. Due to our policy of innovation some specifications may be changed without notification.
2. Wiring cable size must comply with the applicable local and national codes. And "Electric characteristics" chapter should be considered for electrical work and design. Especially the power cable and circuit breaker should be selected in accordance with that.
3. Sound power level is measured on the rated condition in accordance with ISO 9614 standard. Therefore, these values can be increased owing to ambient conditions during operation.
4. Performances are based on the following conditions (It is according to EN14511) :
  - Interconnected Pipe Length is standard length and difference of Elevation (Outdoor ~ Indoor Unit) is 0m.
5. This product contains Fluorinated greenhouse gases.
6. \*: These values are accordance with EN14825.
7. \*\*: These values are accordance with EN16147.

## 2. Specifications

### ■ Combination with IWT

Nominal Capacity and Nominal Input				Indoor unit	ZHNW2060610 [HN0916T NB1]		
-	Condition	Outdoor Temp. (°C) DB / WB	Leaving Water Temp. (°C)	Outdoor Unit	ZHUW056A0 [HU051MR U44]	ZHUW076A0 [HU071MR U44]	ZHUW096A0 [HU091MR U44]
Capacity	Cooling	35 / 24	18	kW	5.50	7.00	9.00
	Heating	7 / 6	35	kW	5.50	7.00	9.00
		7 / 6	55	kW	5.00	5.25	5.50
Power Input	Cooling	35 / 24	18	kW	1.20	1.59	2.20
	Heating	7 / 6	35	kW	1.22	1.56	2.05
		7 / 6	55	kW	1.92	2.02	2.12
EER	Cooling	35 / 24	18	W/W	4.60	4.40	4.10
COP	Heating	7 / 6	35	W/W	4.50	4.50	4.40
		7 / 6	55	W/W	2.60	2.60	2.60
SCOP (Low temp. Average)*					4.52	4.47	4.45
SCOP (High temp. Average)*					3.01	3.00	3.03
Water Heating Efficiency(profile L)**				%	125	125	125
Rated Water Flow Rate (at LWT 35°C)				LPM	15.81	20.12	25.87

Technical Specifications			Indoor unit	ZHNW2060610 [HN0916T NB1]		
			Outdoor Unit	ZHUW056A0 [HU051MR U44]	ZHUW076A0 [HU071MR U44]	ZHUW096A0 [HU091MR U44]
Sound Power Level	Heating	Rated	dB(A)	60	61	61
		Low noise	dB(A)	58	58	58
Dimensions	Net	W × H × D	mm	950 × 834 × 330	950 × 834 × 330	950 × 834 × 330
	Shipping	W × H × D	mm	1,065 × 618 × 461	1,065 × 618 × 461	1,065 × 618 × 461
Weight	Net		kg	60.0	60.0	60.0
	Shipping		kg	65.0	65.0	65.0
Exterior	Color		-	Warm Gray	Warm Gray	Warm Gray
	RAL Code		-	RAL 7044	RAL 7044	RAL 7044

Electrical Specifications			Indoor unit	ZHNW2060610 [HN0916T NB1]		
			Outdoor Unit	ZHUW056A0 [HU051MR U44]	ZHUW076A0 [HU071MR U44]	ZHUW096A0 [HU091MR U44]
Power Supply			V, Ø, Hz	220-240, 1, 50	220-240, 1, 50	220-240, 1, 50
Peak Control Running Current	Cooling		A	13.0	14.0	15.0
	Heating		A	13.0	14.0	15.0
Rated Running Current	Cooling		A	5.3	7.1	9.8
	Heating		A	5.4	6.9	9.1
Circuit breaker			A	16	20	25
Wiring Connections	Power Supply Cable (H07RN-F) (included Earth)		mm <sup>2</sup> x cores	4.0 x 3C	4.0 x 3C	4.0 x 3C

#### Note

- Due to our policy of innovation some specifications may be changed without notification.
- Wiring cable size must comply with the applicable local and national codes. And "Electric characteristics" chapter should be considered for electrical work and design. Especially the power cable and circuit breaker should be selected in accordance with that.
- Sound power level is measured on the rated condition in accordance with ISO 9614 standard. Therefore, these values can be increased owing to ambient conditions during operation.
- Performances are based on the following conditions (It is according to EN14511) :
  - Interconnected Pipe Length is standard length and difference of Elevation (Outdoor ~ Indoor Unit) is 0m.
- This product contains Fluorinated greenhouse gases.
- \*: These values are accordance with EN14825.
- \*\* : These values are accordance with EN16147.

## 2. Specifications

### 2.2 Outdoor unit

Outdoor Units				ZHUW056A0 [HU051MR U44]	ZHUW076A0 [HU071MR U44]	ZHUW096A0 [HU091MR U44]
Operation Range (Outdoor Temperature)	Cooling	Min. ~ Max.	°C DB	5 ~ 48	5 ~ 48	5 ~ 48
	Heating	Min. ~ Max.	°C DB	-25 ~ 35	-25 ~ 35	-25 ~ 35
Compressor	Type	Hermetic Sealed Scroll				
	Model	Model × No.				
	Motor Type	RJB036MAA × 1				
	Displacement	cm <sup>3</sup> /Rev.		BLDC	BLDC	BLDC
Refrigerant	Type	-				
	GWP (Global Warming Potential)	-				
	Precharged Amount	g		31.6	31.6	31.6
	t-CO2 eq.	-				
	Control	Electronic Expansion Valve				
Refrigerant Oil	Type	-				
	Charged Volume	cc × No.		FW68D	FW68D	FW68D
Piping Connections	Gas	Type	Flare			
		mm(Inch)	Φ 15.88 (5/8)			
	Liquid	Type	Flare			
		mm(Inch)	Φ 9.52 (3/8)			
	Piping Length	Standard	m	5	5	5
		Max.	m	50	50	50
	Piping Level Difference	Max.	m	30	30	30
	Chargeless-Pipe Length	m		10	10	10
Additional Charging Volume	g/m		40	40	40	
Heat Exchanger	Quantity	EA		1	1	1
	Specification	Row	EA	2	2	2
		Column	EA	38	38	38
		FPI	EA	14	14	14
Fan	Type	-				
	Air Flow Rate	Rated	m <sup>3</sup> /min × No.	60.0 × 1	60.0 × 1	60.0 × 1
Fan Motor	Type	-				
	Output	W × No.		124 × 1	124 × 1	124 × 1

**Note**

1. Due to our policy of innovation some specifications may be changed without notification.
2. Wiring cable size must comply with the applicable local and national codes. And "Electric characteristics" chapter should be considered for electrical work and design. Especially the power cable and circuit breaker should be selected in accordance with that.
3. Sound power level is measured on the rated condition in according with ISO 9614 standard. Therefore, these values can be increased owing to ambient conditions during operation.
4. Performances are based on the following conditions (It is according to EN14511) :
  - Interconnected Pipe Length is standard length and difference of Elevation (Outdoor ~ Indoor Unit) is 0m.
5. This product contains Fluorinated greenhouse gases.

### 3. Dimensions

◆ ZHUW056A0 [HU051MR U44], ZHUW076A0 [HU071MR U44], ZHUW096A0 [HU091MR U44]

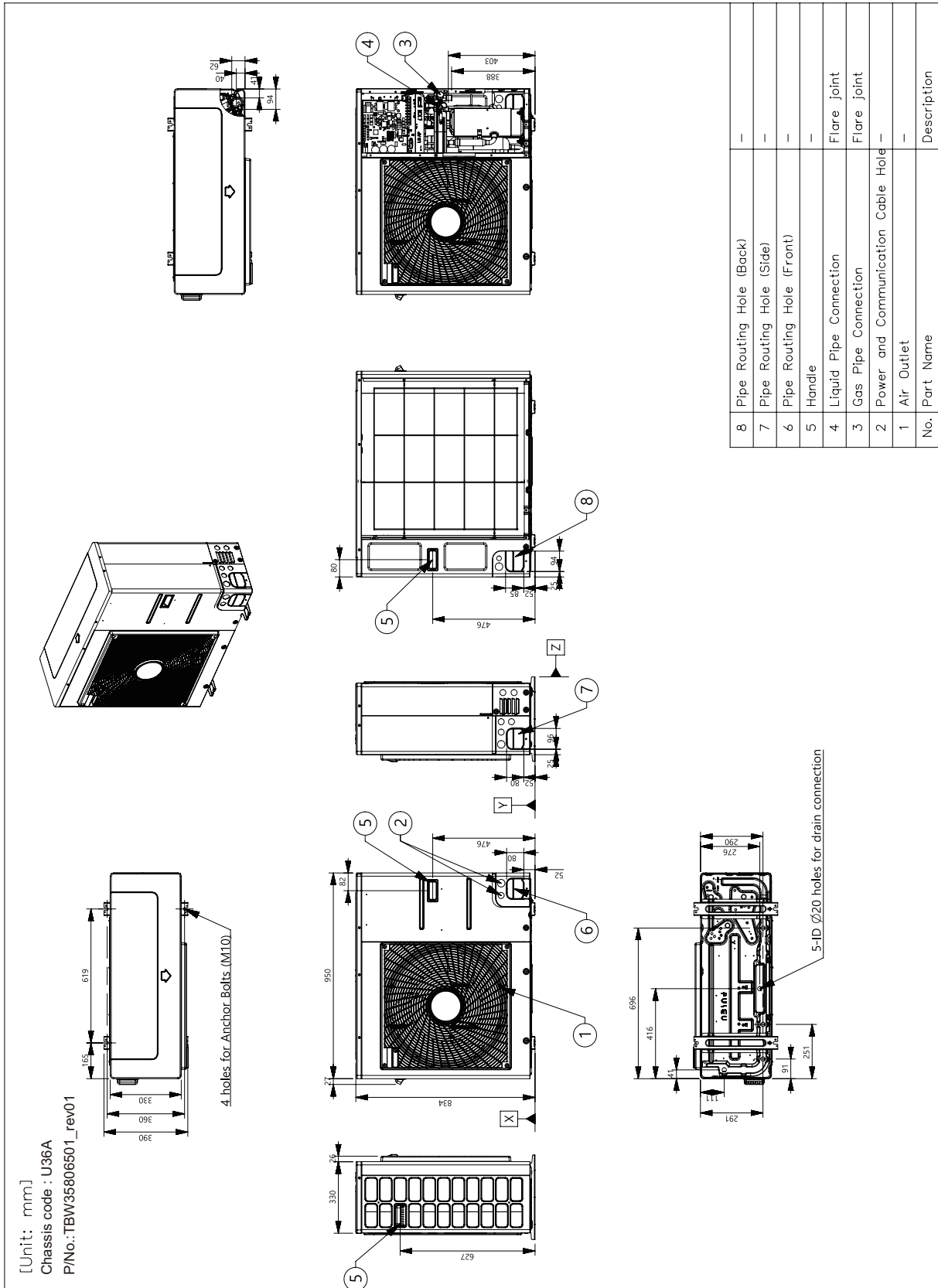

# 4. Wiring Diagram

◆ ZHUW056A0 [HU051MR U44], ZHUW076A0 [HU071MR U44], ZHUW096A0 [HU091MR U44]

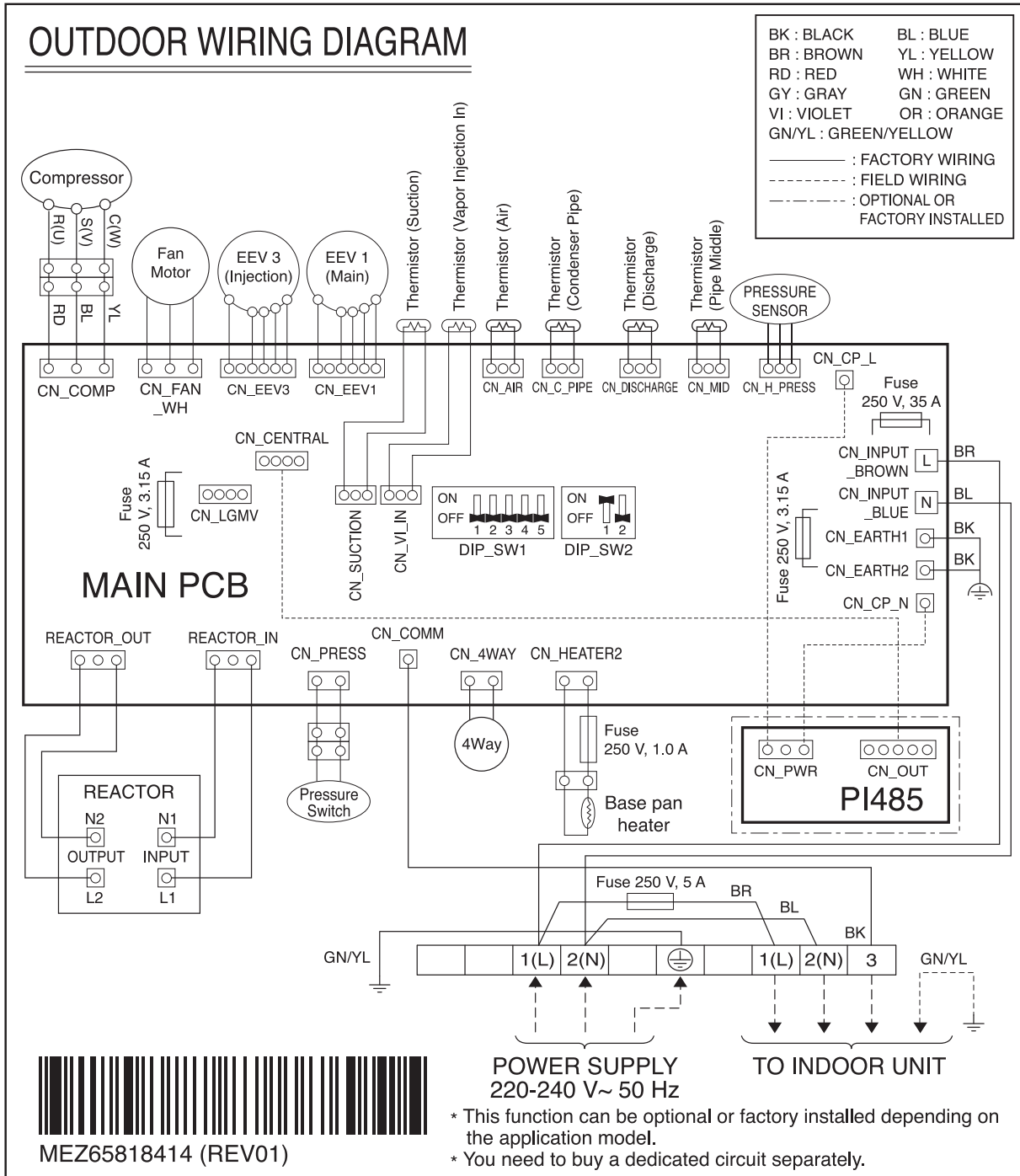

# 5. Piping Diagram

◆ ZHUW056A0 [HU051MR U44], ZHUW076A0 [HU071MR U44], ZHUW096A0 [HU091MR U44]

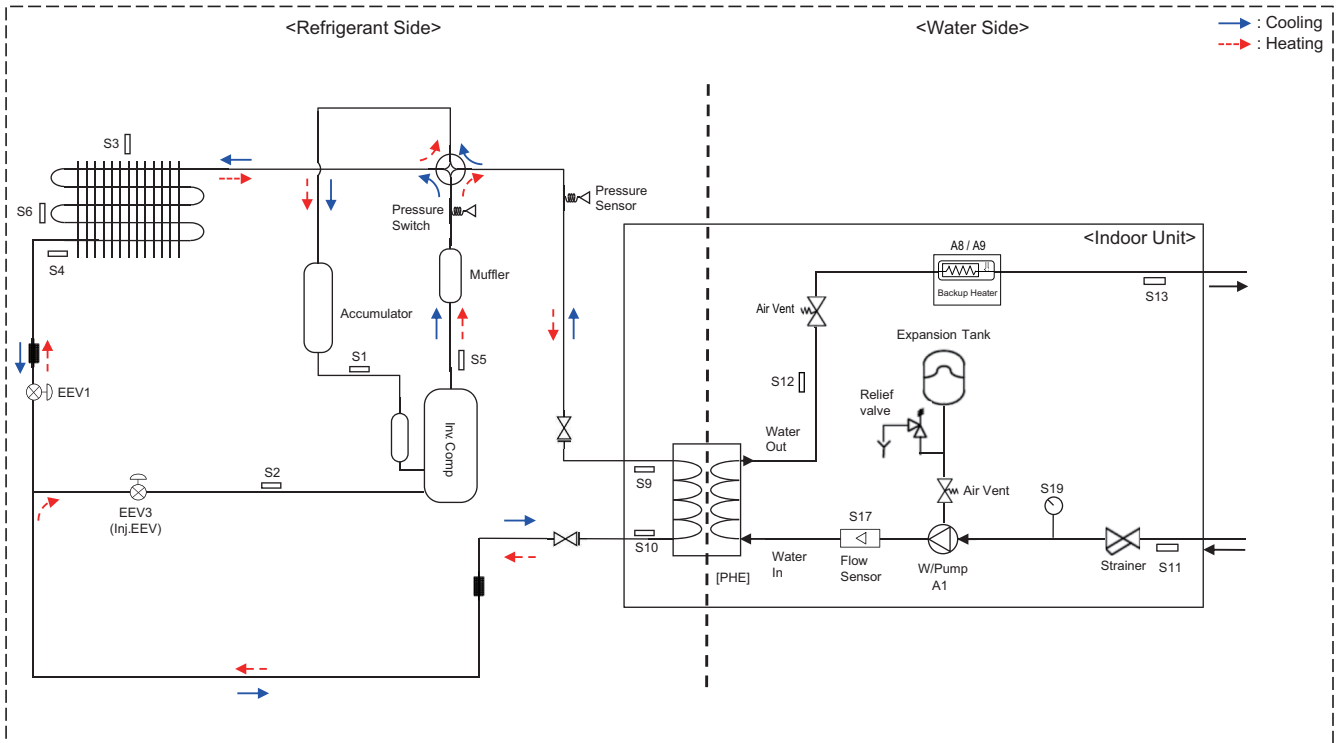

\* This is a piping diagram when combined with hydro box kit. Refer to the indoor unit for the piping diagram of the IWT.

Category	Symbol	Meaning	PCB Connector
Refrigerant side	S1	Compressor-suction pipe temperature sensor	CN_SUCTION(GR)
	S2	Injection EEV discharge temperature sensor	CN_VI_IN(WH)
	S3	Outdoor air temperature sensor	CN_AIR(YL)
	S4	Outdoor-HEX temperature sensor	CN_C_PIPE(VI)
	S5	Compressor-discharge pipe temperature sensor	CN_DISCHARGE(BK)
	S6	Outdoor-HEX middle temperature sensor	CN_MID(BR)
	S9	PHEX gas temperature sensor	CN_PIPE_OUT(RD)
	S10	PHEX liquid temperature sensor	CN_PIPE_IN(WH)
	EEV1	Electronic Expansion Valve	CN_EEV1(WH)
EEV3	EEV3 Electronic Expansion Valve (Injection)	CN_EEV3(YL)	
Water Side	S11	Inlet water temperature sensor (WATER IN)	CN_TH3(BK)
	S12	Outlet water temperature sensor (PHEX OUT)	
	S13	Backup heater outlet sensor (WATER OUT)	
	S17	Flow sensor	CN_F_SENSOR(BL)
	S19	Pressure sensor	CN_H2O_PRESS(OR)
	A1	Main water pump	CN_PUMP_A1(RD)
	A8	Electric backup heater (Step1)	CN_L1 CN_N1
A9	Electric backup heater (Step 2)	CN_L2 CN_N2	



## 6. Performance Data

### 6.1 Cooling Operation

#### 6.1.1 Combination with Hydro Box type

##### ■ Maximum Cooling Capacity

##### ◆ ZHUW056A0 [HU051MR U44] + ZHNW09606A1 [HN091MR NK5]

Outdoor Temperature [°C DB]	Water flow rate 15.8 LPM													
	LWT 7 °C		LWT 10 °C		LWT 13 °C		LWT 15 °C		LWT 18 °C		LWT 20 °C		LWT 22 °C	
	TC	COP	TC	COP	TC	COP	TC	COP	TC	COP	TC	COP	TC	COP
10	6.42	4.57	6.95	4.85	7.49	5.13	7.85	5.31	8.39	5.59	8.75	5.78	9.11	5.96
20	6.05	3.86	6.37	4.23	6.70	4.61	6.91	4.86	7.23	5.23	7.45	5.48	7.66	5.74
30	5.68	3.15	5.79	3.62	5.90	4.09	5.97	4.41	6.08	4.88	6.15	5.19	6.22	5.51
35	5.50	2.80	5.50	3.32	5.50	3.84	5.50	4.18	5.50	4.60	5.50	5.05	5.50	5.39
40	5.32	2.45	5.34	2.84	5.35	3.24	5.37	3.50	5.38	3.90	5.40	4.17	5.41	4.43
45	5.13	2.09	5.17	2.37	5.21	2.64	5.23	2.83	5.27	3.10	5.29	3.29	5.32	3.47

##### ◆ ZHUW076A0 [HU071MR U44] + ZHNW09606A1 [HN091MR NK5]

Outdoor Temperature [°C DB]	Water flow rate 20.1 LPM													
	LWT 7 °C		LWT 10 °C		LWT 13 °C		LWT 15 °C		LWT 18 °C		LWT 20 °C		LWT 22 °C	
	TC	COP	TC	COP	TC	COP	TC	COP	TC	COP	TC	COP	TC	COP
10	8.17	4.37	8.85	4.64	9.54	4.91	9.99	5.09	10.68	5.35	11.13	5.53	11.59	5.71
20	7.70	3.70	8.11	4.06	8.52	4.42	8.80	4.66	9.21	5.01	9.48	5.25	9.75	5.49
30	7.23	3.03	7.37	3.48	7.51	3.93	7.60	4.22	7.74	4.67	7.83	4.97	7.92	5.27
35	7.00	2.70	7.00	3.19	7.00	3.68	7.00	4.01	7.00	4.50	7.00	4.83	7.00	5.15
40	6.77	2.37	6.79	2.74	6.81	3.11	6.83	3.36	6.85	3.74	6.87	3.99	6.88	4.24
45	6.53	2.03	6.58	2.29	6.63	2.55	6.66	2.72	6.70	2.98	6.74	3.15	6.77	3.32

##### ◆ ZHUW096A0 [HU091MR U44] + ZHNW09606A1 [HN091MR NK5]

Outdoor Temperature [°C DB]	Water flow rate 25.9 LPM													
	LWT 7 °C		LWT 10 °C		LWT 13 °C		LWT 15 °C		LWT 18 °C		LWT 20 °C		LWT 22 °C	
	TC	COP	TC	COP	TC	COP	TC	COP	TC	COP	TC	COP	TC	COP
10	10.50	4.08	11.38	4.33	12.26	4.58	12.85	4.75	13.73	5.00	14.31	5.16	14.90	5.33
20	9.90	3.49	10.43	3.81	10.96	4.14	11.31	4.35	11.84	4.68	12.19	4.89	12.54	5.11
30	9.30	2.90	9.48	3.30	9.65	3.69	9.77	3.96	9.95	4.36	10.06	4.63	10.18	4.89
35	9.00	2.60	9.00	3.04	9.00	3.47	9.00	3.76	9.00	4.20	9.00	4.49	9.00	4.78
40	8.70	2.30	8.73	2.63	8.76	2.96	8.78	3.18	8.81	3.50	8.83	3.72	8.85	3.94
45	8.40	2.01	8.46	2.23	8.52	2.44	8.56	2.59	8.62	2.81	8.66	2.95	8.70	3.10

##### Note

1. DB : Dry bulb temperature(°C), LWT : Leaving water temperature(°C), LPM : Liter per minute (ℓ/min)
2. TC : Total capacity(kW), EER: Energy efficiency ratio(kW/kW), COP : Coefficient of performance (kW/kW)
3. Direct interpolation is permissible. Do not extrapolate.
4. Measuring procedure follows EN14511.
  - Rated values are based on standard conditions, and it can be found on specifications.
  - Above table values may not be matched according to installation condition. Except for rated value, the performance is not guaranteed.
  - In accordance with the test standard(or nations), the results may vary.
5. The Shaded areas are not guaranteed continuous operation.

## 6. Performance Data

### 6.1.2 Combination with IWT

#### ◆ ZHUW056A0 [HU051MR U44] + ZHNW2060610 [HN0916T NB1]

Outdoor Temperature [°C DB]	Water flow rate 15.8 LPM													
	LWT 7 °C		LWT 10 °C		LWT 13 °C		LWT 15 °C		LWT 18 °C		LWT 20 °C		LWT 22 °C	
	TC	COP	TC	COP	TC	COP	TC	COP	TC	COP	TC	COP	TC	COP
10	6.42	4.47	6.95	4.74	7.49	5.02	7.85	5.20	8.39	5.47	8.75	5.66	9.11	5.84
20	6.05	3.80	6.37	4.16	6.70	4.52	6.91	4.76	7.23	5.12	7.45	5.36	7.66	5.60
30	5.68	3.13	5.79	3.58	5.90	4.03	5.97	4.33	6.08	4.77	6.15	5.07	6.22	5.37
35	5.50	2.80	5.50	3.29	5.50	3.78	5.50	4.11	5.50	4.60	5.50	4.93	5.50	5.25
40	5.32	2.47	5.34	2.84	5.35	3.21	5.37	3.46	5.38	3.83	5.40	4.08	5.41	4.32
45	5.13	2.13	5.17	2.39	5.21	2.64	5.23	2.81	5.27	3.06	5.29	3.23	5.32	3.40

#### ◆ ZHUW076A0 [HU071MR U44] + ZHNW2060610 [HN0916T NB1]

Outdoor Temperature [°C DB]	Water flow rate 20.1 LPM													
	LWT 7 °C		LWT 10 °C		LWT 13 °C		LWT 15 °C		LWT 18 °C		LWT 20 °C		LWT 22 °C	
	TC	COP	TC	COP	TC	COP	TC	COP	TC	COP	TC	COP	TC	COP
10	8.17	4.27	8.85	4.54	9.54	4.80	9.99	4.97	10.68	5.23	11.13	5.41	11.59	5.58
20	7.70	3.62	8.11	3.97	8.52	4.32	8.80	4.55	9.21	4.90	9.48	5.13	9.75	5.37
30	7.23	2.97	7.37	3.40	7.51	3.84	7.60	4.13	7.74	4.57	7.83	4.86	7.92	5.15
35	7.00	2.64	7.00	3.12	7.00	3.60	7.00	3.92	7.00	4.40	7.00	4.72	7.00	5.04
40	6.77	2.31	6.79	2.68	6.81	3.05	6.83	3.29	6.85	3.66	6.87	3.90	6.88	4.14
45	6.53	1.99	6.58	2.24	6.63	2.49	6.66	2.66	6.70	2.91	6.74	3.08	6.77	3.25

#### ◆ ZHUW096A0 [HU091MR U44] + ZHNW2060610 [HN0916T NB1]

Outdoor Temperature [°C DB]	Water flow rate 25.9 LPM													
	LWT 7 °C		LWT 10 °C		LWT 13 °C		LWT 15 °C		LWT 18 °C		LWT 20 °C		LWT 22 °C	
	TC	COP	TC	COP	TC	COP	TC	COP	TC	COP	TC	COP	TC	COP
10	10.50	3.98	11.38	4.23	12.26	4.47	12.85	4.63	13.73	4.88	14.31	5.04	14.90	5.20
20	9.90	3.40	10.43	3.72	10.96	4.04	11.31	4.25	11.84	4.57	12.19	4.78	12.54	4.99
30	9.30	2.83	9.48	3.22	9.65	3.61	9.77	3.87	9.95	4.26	10.06	4.52	10.18	4.77
35	9.00	2.54	9.00	2.96	9.00	3.39	9.00	3.67	9.00	4.10	9.00	4.38	9.00	4.67
40	8.70	2.25	8.73	2.57	8.76	2.89	8.78	3.10	8.81	3.42	8.83	3.63	8.85	3.85
45	8.40	1.96	8.46	2.17	8.52	2.39	8.56	2.53	8.62	2.74	8.66	2.88	8.70	3.03

#### Note

1. DB : Dry bulb temperature(°C), LWT : Leaving water temperature(°C), LPM : Liter per minute (ℓ/min)
2. TC : Total capacity(kW), EER: Energy efficiency ratio(kW/kW), COP : Coefficient of performance (kW/kW)
3. Direct interpolation is permissible. Do not extrapolate.
4. Measuring procedure follows EN14511.
  - Rated values are based on standard conditions, and it can be found on specifications.
  - Above table values may not be matched according to installation condition. Except for rated value, the performance is not guaranteed.
  - In accordance with the test standard(or nations), the results may vary.
5. The Shaded areas are not guaranteed continuous operation.

## 6. Performance Data

### 6.2 Heating Operation

#### 6.2.1 Combination with Hydro Box type

##### ■ Maximum Heating Capacity (Include defrost effect)

##### ◆ ZHUW056A0 [HU051MR U44] + ZHNW09606A1 [HN091MR NK5]

Outdoor Temperature [°C DB]	Water flow rate 15.8 LPM								Water flow rate 9.9 LPM				Water flow rate 7.9 LPM			
	LWT 30 °C		LWT 35 °C		LWT 40 °C		LWT 45 °C		LWT 50 °C		LWT 55 °C		LWT 60 °C		LWT 65 °C	
	TC	COP	TC	COP	TC	COP	TC	COP	TC	COP	TC	COP	TC	COP	TC	COP
-25	4.02	1.96	3.90	1.84	3.78	1.72	3.66	1.60								
-20	4.64	2.59	4.51	2.07	4.38	1.90	4.26	1.74	4.13	1.57						
-15	5.26	2.51	5.12	2.30	4.99	2.09	4.85	1.88	4.72	1.66	4.58	1.45				
-7	5.50	2.88	5.50	2.70	5.50	2.53	5.50	2.35	5.50	2.18	5.50	2.00	5.50	1.83		
-4	5.50	3.18	5.50	2.97	5.50	2.75	5.50	2.53	5.50	2.31	5.50	2.10	5.50	1.88		
-2	5.50	3.41	5.50	3.14	5.50	2.88	5.50	2.61	5.50	2.34	5.50	2.08	5.50	1.81		
2	5.50	3.79	5.50	3.50	5.50	3.21	5.50	2.93	5.50	2.64	5.50	2.36	5.50	2.07	5.50	1.79
7	5.50	5.37	5.50	4.90	5.50	4.43	5.50	3.97	5.50	3.50	5.50	3.03	5.50	2.57	5.50	2.10
10	5.50	5.84	5.50	5.34	5.50	4.83	5.50	4.32	5.50	3.81	5.50	3.30	5.50	2.79	5.50	2.29
15	5.50	6.64	5.50	6.06	5.50	5.48	5.50	4.91	5.50	4.33	5.50	3.75	5.50	3.17	5.50	2.60
18	5.50	7.11	5.50	6.50	5.50	5.88	5.50	5.26	5.50	4.64	5.50	4.02	5.50	3.40	5.50	2.78
20	5.50	7.43	5.50	6.79	5.50	6.14	5.50	5.49	5.50	4.85	5.50	4.20	5.50	3.55	5.50	2.91
35	5.50	9.81	5.50	8.96	5.50	8.11	5.50	7.25	5.50	6.40	5.50	5.55	5.50	4.69	5.50	3.84

##### ◆ ZHUW076A0 [HU071MR U44] + ZHNW09606A1 [HN091MR NK5]

Outdoor Temperature [°C DB]	Water flow rate 20.1 LPM								Water flow rate 12.6 LPM				Water flow rate 10.0 LPM			
	LWT 30 °C		LWT 35 °C		LWT 40 °C		LWT 45 °C		LWT 50 °C		LWT 55 °C		LWT 60 °C		LWT 65 °C	
	TC	COP	TC	COP	TC	COP	TC	COP	TC	COP	TC	COP	TC	COP	TC	COP
-25	5.00	1.95	4.85	1.78	4.71	1.62	4.56	1.45								
-20	5.58	2.52	5.43	2.02	5.27	1.84	5.11	1.66	4.95	1.49						
-15	6.17	2.44	6.00	2.25	5.83	2.06	5.66	1.88	5.49	1.69	5.32	1.50				
-7	7.00	2.76	7.00	2.72	7.00	2.44	7.00	2.28	7.00	2.11	7.00	2.06	7.00	1.79		
-4	7.00	3.07	7.00	2.87	7.00	2.66	7.00	2.45	7.00	2.24	7.00	2.08	7.00	1.83		
-2	7.00	3.27	7.00	3.04	7.00	2.82	7.00	2.59	7.00	2.37	7.00	2.14	7.00	2.06		
2	7.00	3.65	7.00	3.40	7.00	3.15	7.00	2.90	7.00	2.66	7.00	2.41	7.00	2.16	7.00	1.91
7	7.00	5.35	7.00	4.90	7.00	4.45	7.00	4.00	7.00	3.55	7.00	3.10	7.00	2.65	7.00	2.20
10	7.00	5.77	7.00	5.28	7.00	4.80	7.00	4.31	7.00	3.83	7.00	3.34	7.00	2.86	7.00	2.37
15	7.00	6.46	7.00	5.92	7.00	5.37	7.00	4.83	7.00	4.29	7.00	3.74	7.00	3.20	7.00	2.66
18	7.00	6.88	7.00	6.30	7.00	5.72	7.00	5.14	7.00	4.56	7.00	3.99	7.00	3.41	7.00	2.83
20	7.00	7.16	7.00	6.55	7.00	5.95	7.00	5.35	7.00	4.75	7.00	4.15	7.00	3.54	7.00	2.94
35	7.00	9.24	7.00	8.46	7.00	7.69	7.00	6.91	7.00	6.13	7.00	5.35	7.00	4.58	7.00	3.80

##### ◆ ZHUW096A0 [HU091MR U44] + ZHNW09606A1 [HN091MR NK5]

Outdoor Temperature [°C DB]	Water flow rate 25.9 LPM								Water flow rate 16.2 LPM				Water flow rate 12.9 LPM			
	LWT 30 °C		LWT 35 °C		LWT 40 °C		LWT 45 °C		LWT 50 °C		LWT 55 °C		LWT 60 °C		LWT 65 °C	
	TC	COP	TC	COP	TC	COP	TC	COP	TC	COP	TC	COP	TC	COP	TC	COP
-25	6.40	1.85	6.20	1.70	6.00	1.55	5.80	1.40								
-20	7.23	2.45	7.00	1.96	6.77	1.80	6.54	1.64	6.31	1.48						
-15	8.06	2.39	7.80	2.22	7.54	2.05	7.28	1.89	7.02	1.72	6.76	1.55				
-7	9.00	2.75	9.00	2.71	9.00	2.35	9.00	2.20	9.00	2.05	9.00	1.90	9.00	1.75		
-4	9.00	2.98	9.00	2.78	9.00	2.58	9.00	2.38	9.00	2.18	9.00	1.98	9.00	1.78		
-2	9.00	3.16	9.00	2.97	9.00	2.78	9.00	2.59	9.00	2.40	9.00	2.21	9.00	2.02		
2	9.00	3.57	9.00	3.35	9.00	3.13	9.00	2.91	9.00	2.69	9.00	2.47	9.00	2.25	9.00	2.04
7	9.00	5.04	9.00	4.65	9.00	4.26	9.00	3.87	9.00	3.48	9.00	3.08	9.00	2.69	9.00	2.30
10	9.00	5.39	9.00	4.97	9.00	4.55	9.00	4.13	9.00	3.71	9.00	3.30	9.00	2.88	9.00	2.46
15	9.00	5.97	9.00	5.50	9.00	5.04	9.00	4.58	9.00	4.11	9.00	3.65	9.00	3.19	9.00	2.72
18	9.00	6.32	9.00	5.83	9.00	5.33	9.00	4.84	9.00	4.35	9.00	3.86	9.00	3.37	9.00	2.88
20	9.00	6.55	9.00	6.04	9.00	5.53	9.00	5.02	9.00	4.51	9.00	4.00	9.00	3.50	9.00	2.99
35	9.00	8.29	9.00	7.64	9.00	7.00	9.00	6.35	9.00	5.71	9.00	5.07	9.00	4.42	9.00	3.78

**Note**

1. DB : Dry bulb temperature(°C), LWT : Leaving water temperature(°C), LPM : Liter per minute (ℓ/min)
2. TC : Total capacity(kW), EER: Energy efficiency ratio(kW/kW), COP : Coefficient of performance (kW/kW)
3. Direct interpolation is permissible. Do not extrapolate.
4. Measuring procedure follows EN14511.
  - Rated values are based on standard conditions, and it can be found on specifications.
  - Above table values may not be matched according to installation condition. Except for rated value, the performance is not guaranteed.
  - In accordance with the test standard(or nations), the results may vary.
5. The Shaded areas are not guaranteed continuous operation.

## 6. Performance Data

### 6.2.2 Combination with IWT

#### ■ Maximum Heating Capacity (Include defrost effect)

##### ◆ ZHUW056A0 [HU051MR U44] + ZHNW2060610 [HN0916T NB1]

Outdoor Temperature [°C DB]	Water flow rate 15.8 LPM								Water flow rate 9.9 LPM				Water flow rate 7.9 LPM			
	LWT 30 °C		LWT 35 °C		LWT 40 °C		LWT 45 °C		LWT 50 °C		LWT 55 °C		LWT 60 °C		LWT 65 °C	
	TC	COP	TC	COP	TC	COP	TC	COP	TC	COP	TC	COP	TC	COP	TC	COP
-25	4.02	1.83	3.90	1.68	3.78	1.53	3.66	1.38								
-20	4.64	1.99	4.51	1.84	4.38	1.69	4.26	1.54	4.13	1.39						
-15	5.26	2.15	5.12	2.00	4.99	1.85	4.85	1.70	4.72	1.54	4.58	1.39				
-7	5.50	2.97	5.50	2.72	5.50	2.47	5.50	2.23	5.50	1.98	5.50	1.73	5.50	1.48		
-4	5.50	3.11	5.50	2.88	5.50	2.65	5.50	2.42	5.50	2.19	5.50	1.96	5.50	1.73		
-2	5.50	3.19	5.50	2.99	5.50	2.80	5.50	2.61	5.50	2.41	5.50	2.22	5.50	2.03		
2	5.50	3.42	5.50	3.21	5.50	3.00	5.50	2.79	5.50	2.57	5.50	2.36	5.50	2.15	5.50	1.94
7	5.50	4.91	5.50	4.50	5.50	4.09	5.50	3.69	5.50	3.28	5.50	2.87	5.50	2.47	5.50	2.06
10	5.50	5.09	5.50	4.66	5.50	4.24	5.50	3.82	5.50	3.40	5.50	2.98	5.50	2.56	5.50	2.14
15	5.50	5.38	5.50	4.94	5.50	4.49	5.50	4.04	5.50	3.60	5.50	3.15	5.50	2.71	5.50	2.26
18	5.50	5.56	5.50	5.10	5.50	4.64	5.50	4.18	5.50	3.72	5.50	3.26	5.50	2.80	5.50	2.34
20	5.50	5.68	5.50	5.21	5.50	4.74	5.50	4.27	5.50	3.80	5.50	3.33	5.50	2.86	5.50	2.39
35	5.50	6.57	5.50	6.03	5.50	5.48	5.50	4.94	5.50	4.39	5.50	3.85	5.50	3.30	5.50	2.76

##### ◆ ZHUW076A0 [HU071MR U44] + ZHNW2060610 [HN0916T NB1]

Outdoor Temperature [°C DB]	Water flow rate 20.1 LPM								Water flow rate 12.6 LPM				Water flow rate 10.0 LPM			
	LWT 30 °C		LWT 35 °C		LWT 40 °C		LWT 45 °C		LWT 50 °C		LWT 55 °C		LWT 60 °C		LWT 65 °C	
	TC	COP	TC	COP	TC	COP	TC	COP	TC	COP	TC	COP	TC	COP	TC	COP
-25	5.00	1.77	4.85	1.62	4.71	1.47	4.56	1.32								
-20	5.58	1.95	5.43	1.80	5.27	1.64	5.11	1.49	4.95	1.34						
-15	6.17	2.13	6.00	1.97	5.83	1.82	5.66	1.66	5.49	1.51	5.32	1.35				
-7	7.00	2.96	7.00	2.71	7.00	2.46	7.00	2.22	7.00	1.97	7.00	1.72	7.00	1.47		
-4	7.00	3.07	7.00	2.85	7.00	2.63	7.00	2.40	7.00	2.18	7.00	1.96	7.00	1.74		
-2	7.00	3.12	7.00	2.94	7.00	2.76	7.00	2.58	7.00	2.39	7.00	2.21	7.00	2.03		
2	7.00	3.31	7.00	3.12	7.00	2.93	7.00	2.74	7.00	2.55	7.00	2.36	7.00	2.17	7.00	1.98
7	7.00	4.89	7.00	4.50	7.00	4.11	7.00	3.72	7.00	3.33	7.00	2.93	7.00	2.54	7.00	2.15
10	7.00	5.12	7.00	4.71	7.00	4.30	7.00	3.89	7.00	3.48	7.00	3.07	7.00	2.66	7.00	2.25
15	7.00	5.50	7.00	5.06	7.00	4.62	7.00	4.18	7.00	3.74	7.00	3.30	7.00	2.86	7.00	2.42
18	7.00	5.73	7.00	5.27	7.00	4.81	7.00	4.36	7.00	3.90	7.00	3.44	7.00	2.98	7.00	2.52
20	7.00	5.88	7.00	5.41	7.00	4.94	7.00	4.47	7.00	4.00	7.00	3.53	7.00	3.06	7.00	2.59
35	7.00	7.03	7.00	6.47	7.00	5.90	7.00	5.34	7.00	4.78	7.00	4.22	7.00	3.65	7.00	3.09

##### ◆ ZHUW096A0 [HU091MR U44] + ZHNW2060610 [HN0916T NB1]

Outdoor Temperature [°C DB]	Water flow rate 25.9 LPM								Water flow rate 16.2 LPM				Water flow rate 12.9 LPM			
	LWT 30 °C		LWT 35 °C		LWT 40 °C		LWT 45 °C		LWT 50 °C		LWT 55 °C		LWT 60 °C		LWT 65 °C	
	TC	COP	TC	COP	TC	COP	TC	COP	TC	COP	TC	COP	TC	COP	TC	COP
-25	6.40	1.71	6.20	1.56	6.00	1.41	5.80	1.26								
-20	7.23	1.87	7.00	1.72	6.77	1.57	6.54	1.42	6.31	1.27						
-15	8.06	2.02	7.80	1.87	7.54	1.72	7.28	1.57	7.02	1.42	6.76	1.27				
-7	9.00	2.97	9.00	2.70	9.00	2.43	9.00	2.17	9.00	1.90	9.00	1.63	9.00	1.36		
-4	9.00	3.08	9.00	2.86	9.00	2.63	9.00	2.41	9.00	2.19	9.00	1.96	9.00	1.74		
-2	9.00	3.15	9.00	2.96	9.00	2.78	9.00	2.59	9.00	2.40	9.00	2.22	9.00	2.03		
2	9.00	3.36	9.00	3.17	9.00	2.98	9.00	2.79	9.00	2.60	9.00	2.40	9.00	2.21	9.00	2.02
7	9.00	4.76	9.00	4.40	9.00	4.04	9.00	3.68	9.00	3.32	9.00	2.96	9.00	2.60	9.00	2.24
10	9.00	5.04	9.00	4.66	9.00	4.28	9.00	3.89	9.00	3.51	9.00	3.13	9.00	2.75	9.00	2.37
15	9.00	5.50	9.00	5.08	9.00	4.67	9.00	4.25	9.00	3.84	9.00	3.42	9.00	3.00	9.00	2.59
18	9.00	5.78	9.00	5.34	9.00	4.90	9.00	4.47	9.00	4.03	9.00	3.59	9.00	3.16	9.00	2.72
20	9.00	5.96	9.00	5.51	9.00	5.06	9.00	4.61	9.00	4.16	9.00	3.71	9.00	3.26	9.00	2.81
35	9.00	7.35	9.00	6.80	9.00	6.24	9.00	5.68	9.00	5.13	9.00	4.57	9.00	4.02	9.00	3.46

**Note**

1. DB : Dry bulb temperature(°C), LWT : Leaving water temperature(°C), LPM : Liter per minute (ℓ/min)
2. TC : Total capacity(kW), EER: Energy efficiency ratio(kW/kW), COP : Coefficient of performance (kW/kW)
3. Direct interpolation is permissible. Do not extrapolate.
4. Measuring procedure follows EN14511.
  - Rated values are based on standard conditions, and it can be found on specifications.
  - Above table values may not be matched according to installation condition. Except for rated value, the performance is not guaranteed.
  - In accordance with the test standard(or nations), the results may vary.
5. The Shaded areas are not guaranteed continuous operation.

# 7. Operation Range

## ■ Cooling

### Cooling

(Settings : Outlet temp. control / Fan coil unit used)

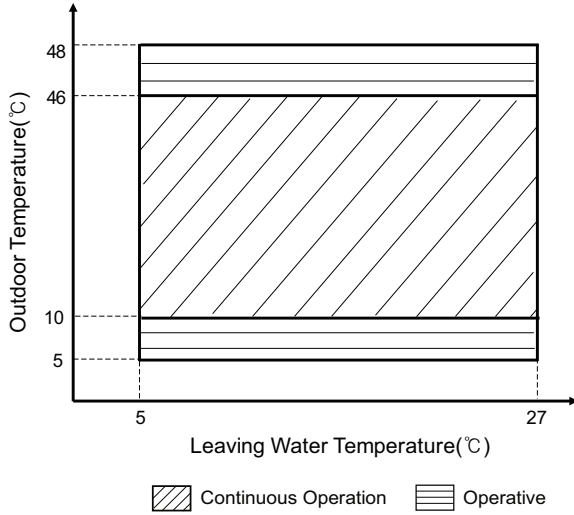

### Cooling

(Settings : Inlet temp. control / Fan coil unit used)

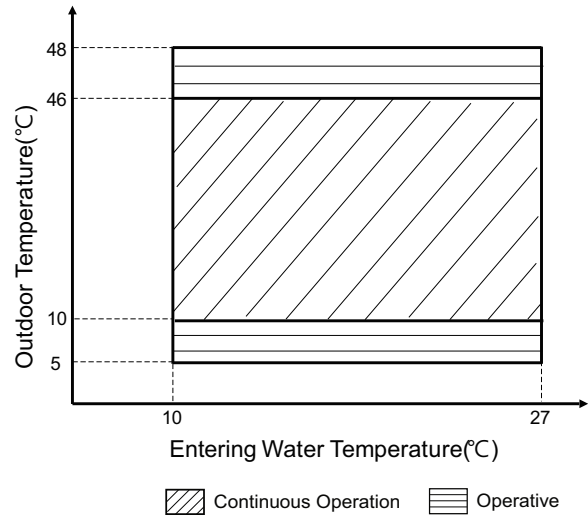

### Cooling

(Settings : Outlet temp. control / Fan coil unit not used)

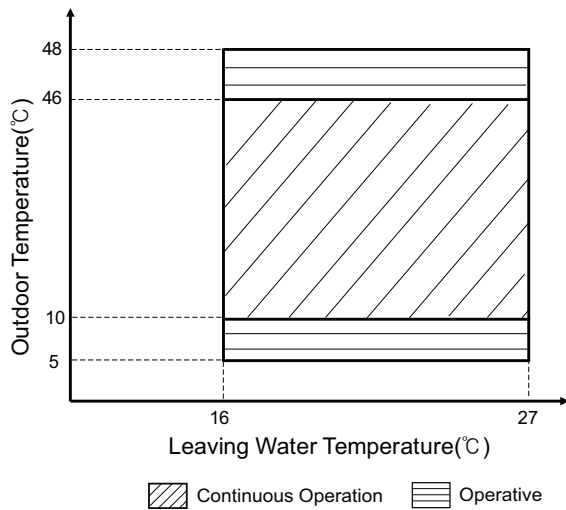

### Cooling

(Settings : Inlet temp. control / Fan coil unit not used)

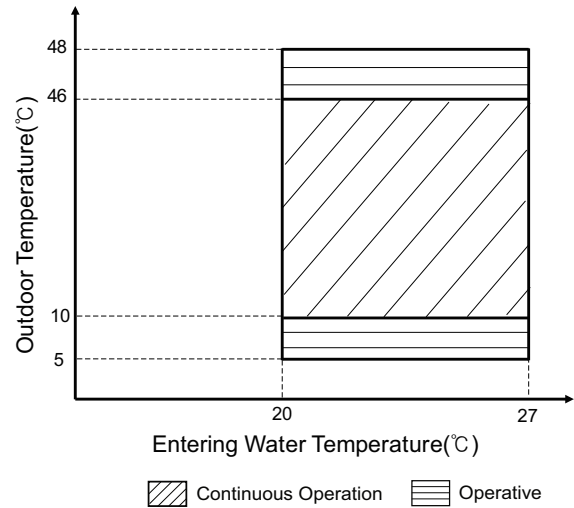

#### Note

- Continuous Operation : It is possible to operate continuously, but capacity is not guaranteed.
- Operative : It is not guaranteed continuous operation.

# 7. Operation Range

## ■ Heating

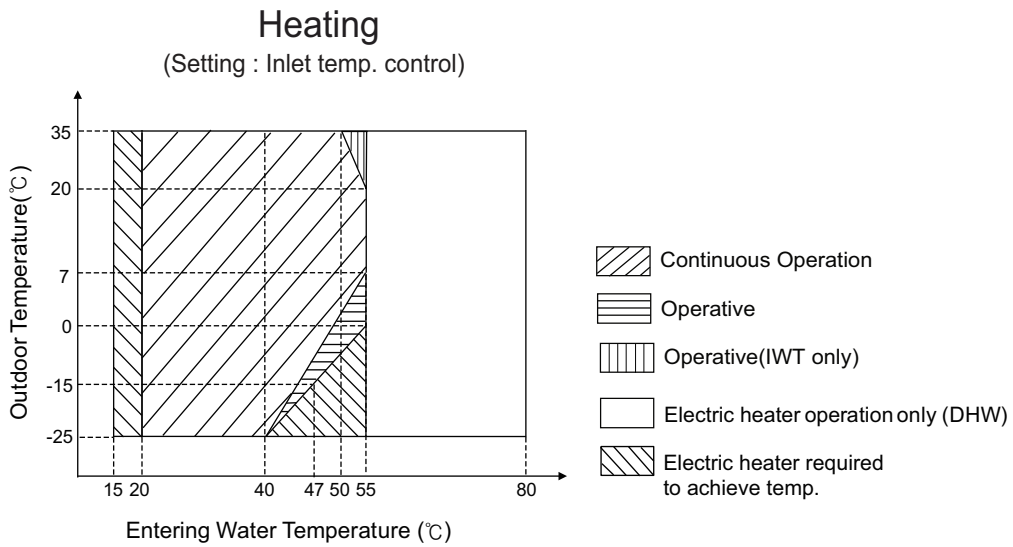
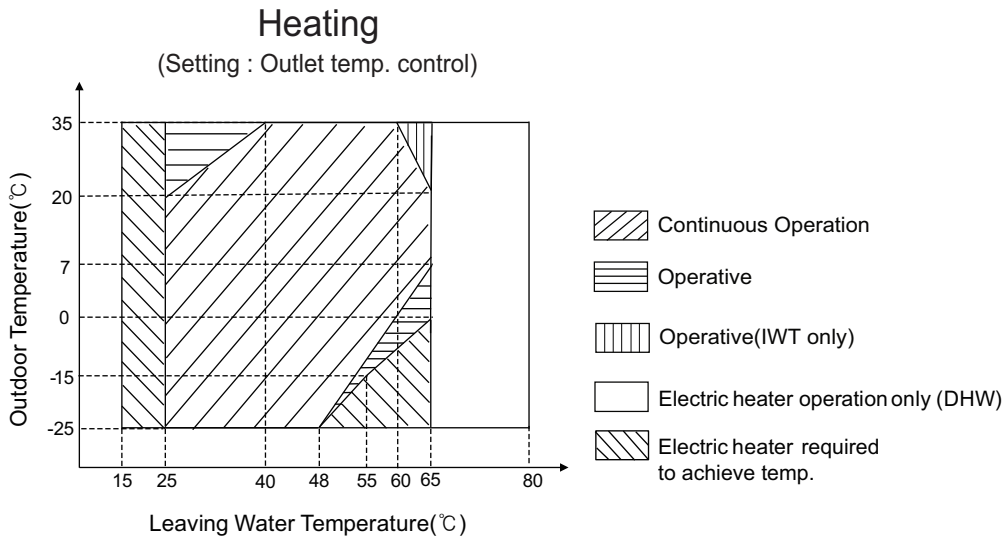

**Note**

- Continuous Operation : It is possible to operate continuously, but capacity is not guaranteed.
- Operative : It is not guaranteed continuous operation.
- DHW operation : max. 58 °C
- DHW operation with Electric heater : max. 80 °C

## 8. Electric characteristics

---

### ■ Wiring of Main Power Supply and Equipment Capacity

1. Use a separate power supply for the Outdoor Unit and Backup Heater.
  2. Bear in mind ambient conditions (ambient temperature, direct sunlight, rain liquid, etc.) when proceeding with the wiring and connections
  3. The wire size is the minimum value for metal conduit wiring. The power cord size should be 1 rank thicker taking into account the line voltage drops. Make sure the power-supply voltage does not drop more than 10%.
  4. Specific wiring requirements should adhere to the wiring regulations of the region.
  5. Power supply cords of parts of appliances for outdoor use should not be lighter than polychloroprene sheathed flexible cord.
  6. Don't install an individual switch or electrical outlet to disconnect the indoor unit separately from the power supply.
- 

### WARNING

- Follow ordinance of your governmental organization for technical standard related to electrical equipment, wiring regulations and guidance of each electric power company.
  - Make sure to use specified wires for connections so that no external force is imparted to terminal connections. If connections are not fixed firmly, it may cause heating or fire.
  - Make sure to use the appropriate type of overcurrent protection switch. Note that generated overcurrent may include some amount of direct current.
- 

### CAUTION

- All installation site must require attachment of an earth leakage breaker. If no earth leakage breaker is installed, it may cause an electric shock.
  - Do not use anything other than breaker and fuse with correct capacity. Using fuse and wire or copper wire with too large capacity may cause a malfunction of unit or fire.
-

# 8. Electric characteristics

## Outdoor Unit and Hydro Box Unit

Indoor Unit	Model		Built-In Electric Heater	
	Outdoor Unit	Phase / Volts / Hz	Capacity (kW)	Phase / Volts
ZHNW09606A1 [HN091MR NK5]	ZHUW056A0 [HU051MR U44]	1 / 220-240V / 50Hz	3 + 3	1 / 220-240 V
	ZHUW076A0 [HU071MR U44]			
	ZHUW096A0 [HU091MR U44]			

DHW Boost Heater Indoor Unit	Power Supply for DHW Boost Heater	
	Phase / Volts / Hz	Capacity (kW)
Integral part of DHW tanks [OSHW-x00F(D)]	1 Ø / 220-240 V / 50 Hz	2.4

**[Power Supply for Heat Pump]**

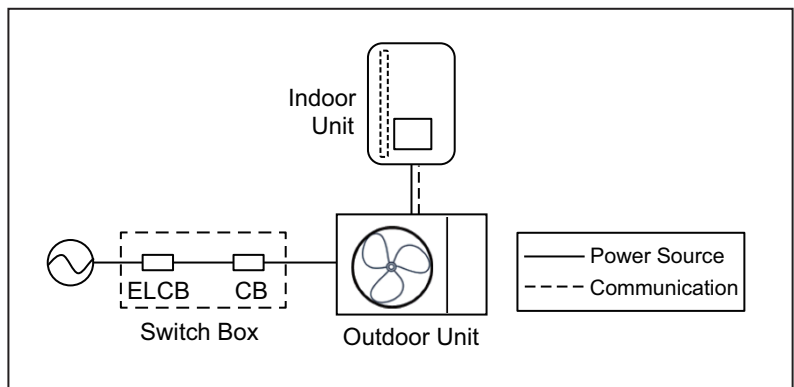

**[Power Supply for Backup Heater]**

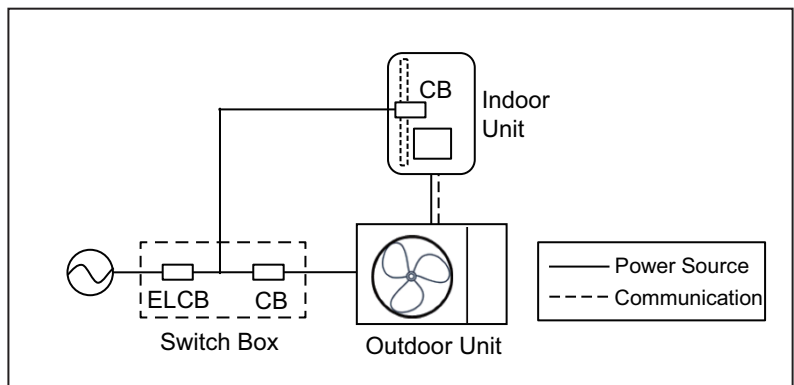

**[Power Supply for DHW Boost Heater]**

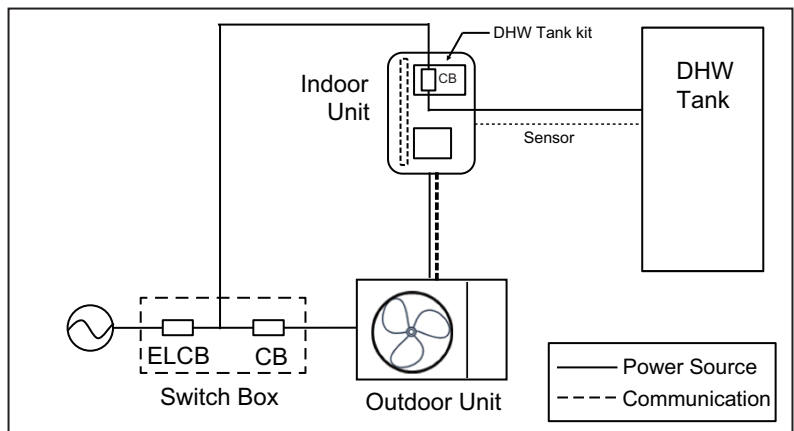

**Note**

1. Voltage supplied to the unit terminals should be within the minimum and maximum range.
2. Maximum allowable voltage unbalance between phase is 2%.
3. All installation site must require attachment of an earth leakage breaker. [circuit breaker type is ELCB(Earth Leakage Circuit Breaker)].



# 8. Electric characteristics

## IWT Unit

Model		Phase / Volts / Hz	Built-In Electric Heater Capacity(kW)*
Indoor Unit	Outdoor Unit		
ZHNW2060610 [HN0916T NB1]	ZHUW056A0 [HU051MR U44]	1 / 220-240V / 50Hz	1Ø 2 (2) 1Ø 4 (2+2) 3Ø 6 (2+2+2)
	ZHUW076A0 [HU071MR U44]		
	ZHUW096A0 [HU091MR U44]		

### [Power Supply for 1Ø Electric heater]

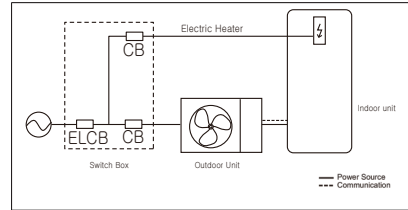

### [Power Supply for 3Ø Electric heater]

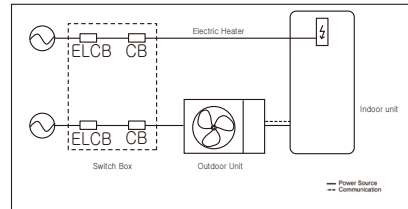

**Note**

1. Voltage supplied to the unit terminals should be within the minimum and maximum range.
2. Maximum allowable voltage unbalance between phase is 2%.
3. All installation site must require attachment of an earth leakage breaker. [circuit breaker type is ELCB(Earth Leakage Circuit Breaker)].
4. \*The capacity of Electrical Heater depend on the choice of the connection power.

## 9. Sound levels

### 9.1 Sound power level

**Note**

1. Data is valid at diffuse field condition.
2. Reference acoustic intensity 0dB = 10E-6μW/m<sup>2</sup>
3. Sound power level is measured on the rated condition in the reverberation rooms. Refer to the Model Specifications for nominal conditions(Power source and Ambient temperature, etc)
4. Sound levels can be increased in accordance with installation and operating conditions.
5. Sound level will vary depending on a range of factors such as the construction (acoustic absorption coefficient) of particular installed place in which the equipment in installed.
6. Sound power level is measured on the rated condition in accordance with ISO 9614 standard. Therefore, these values can be increased owing to ambient conditions during operation.

■ **Combination with Hydro Box type**

Model		Sound Power Level [dB(A)]	
		Heating	
Indoor Unit	Outdoor Unit	Rated	Low Noise
ZHNW09606A1 [HN091MR NK5]	ZHUW056A0 [HU051MR U44]	60	58
	ZHUW076A0 [HU071MR U44]	60	58
	ZHUW096A0 [HU091MR U44]	60	58

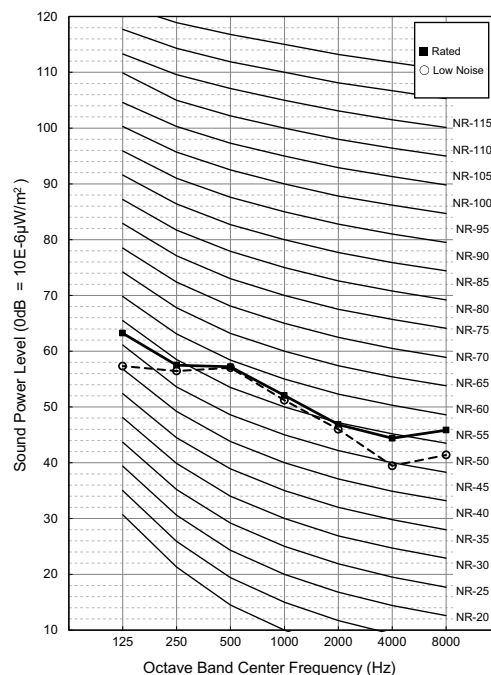

# 9. Sound levels

## ■ Combination with IWT

Model		Sound Power Level [dB(A)]	
		Heating	
Indoor Unit	Outdoor Unit	Rated	Low Noise
ZHNW20606I0 [HN0916T NB1]	ZHUW056A0 [HU051MR U44]	60	58
	ZHUW076A0 [HU071MR U44]	61	58
	ZHUW096A0 [HU091MR U44]	61	58

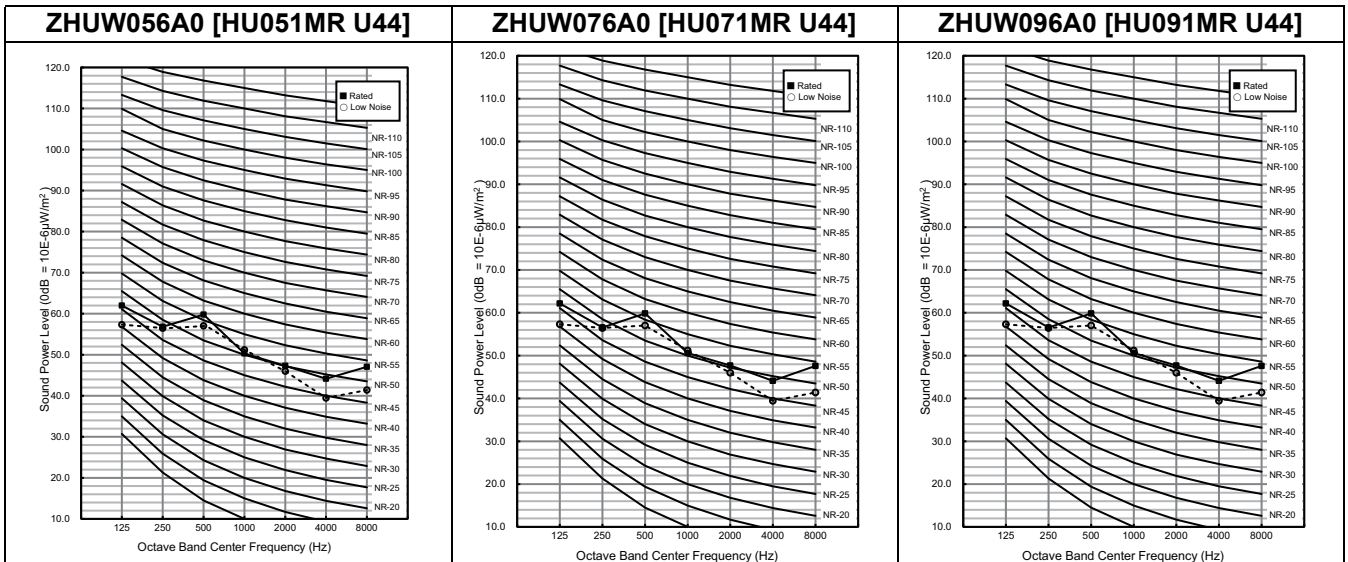

# ***THERMA V***<sup>TM</sup>

## Split Type

### **Design and installation**

- 1.Refrigerant R32**
- 2.Select the Best Location**
- 3.Installation Space**
- 4.Water Control**
- 5.Dip Switch Setting**

## 1. Refrigerant R32

---

The refrigerant R32 has the higher efficiency and more friendly for environment in comparison with R410A. It has a lower GWP (Global Warming Potential) value, and higher efficiency than R410A. The Ozone Depletion Potential (ODP) of R32 is 0, and Global Warming Potential(GWP) is 675.

Refrigerant piping consists of copper/steel pipes, joints, and other fittings. All components must be selected and installed in conformity with the standards pertaining to the Refrigeration Safety Regulation. Same piping as for R410A can be used.

---

### **WARNING**

- This product contains fluorinated greenhouse gases (Refrigerant type : R32). Do NOT emit refrigerant gases into the atmosphere.
  - The refrigerant R32 is Slightly Flammable gas. But it does not leak normally. If the refrigerant leaks in the installed place and contact with burning energy, it may cause fire, or a harmful gas.
  - If there are some leak, turn off any combustible devices, ventilate the installed place, and contact the dealer from which you purchased the unit. Do not use the unit until the refrigerant leaked is repaired.
  - Only use R32 as refrigerant. Other substances may cause explosions and accidents.
- 

### **CAUTION**

- The wall thickness of the piping should comply with the relevant local and national regulations for the designed pressure.
  - For high-pressure refrigerant, any unapproved pipe must not be used.
  - Do not heat pipes more than necessary to prevent them from softening.
-

## 2. Select the Best Location

---

Select space for installing unit, which will meet the following conditions:

- No direct thermal radiation from other heat sources
- No possibility of annoying neighbors by noise from unit
- No exposition to strong wind
- With strength which bears weight of unit
- With space for air passage and service work shown next
- Because of the possibility of fire, do not install unit to the space where generation, inflow, stagnation, and leakage of combustible gas is expected.
- Avoid unit installation in a place where acidic solution and spray (sulfur) are often used.
- Do not use unit under any special environment where oil, steam and sulfuric gas exist.
- It is recommended to fence round the unit in order to prevent any person or animal from accessing the unit.
- If installation site is area of heavy snowfall, then the following directions should be observed.
  - Make the foundation as high as possible.
  - Fit a snow protection hood.
- Select installation location considering following conditions to avoid bad condition when additionally performing defrost operation.
  1. Install the unit at a place well ventilated and having a lot of sunshine in case of installing the product at a place with a high humidity in winter (near beach, coast, lake, etc).
  2. Performance of heating will be reduced and pre-heat time of the unit may be lengthened in case of installing the unit in winter at following location:
    - 1) Shade position with a narrow space
    - 2) Location with much humidity around.
    - 3) Location where liquid gathers since the floor is not even.
- When installing the unit in a place that is constantly exposed to a strong wind like a coast or on a high story of a building, secure a normal fan operation by using a duct or a wind shield.
  1. Install the unit so that its discharge port faces to the wall of the building. Keep a distance 300 mm or more between the unit and the wall surface.
  2. Supposing the wind direction during the operation season of the unit, install the unit so that the discharge port is set at right angle to the wind direction.

### 3. Installation Space

#### 3.1 Clearance around outdoor units

- Ensure that the space around the back is or more more than 300 mm on the opposite to the PCB side and secure 600 mm space near the compressor and PCB side of the air conditioner for service.

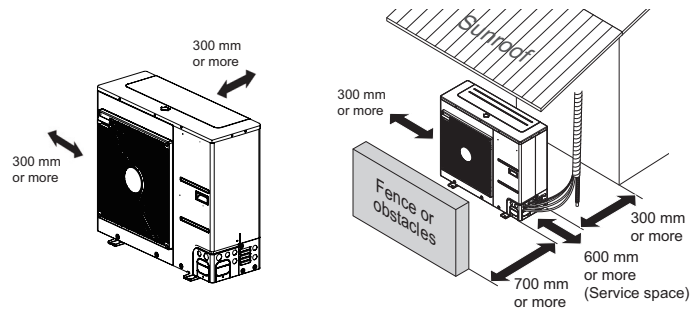

※ Outdoor unit is representative. Actual appearance of outdoor unit may be different but clearances will stay the same.

- Install the unit so that its discharge port faces to the wall of the building. Keep a distance 500mm or more between the unit and the wall surface.
- Supposing the wind direction during the operation season of the air conditioner, install the unit so that the discharge port is set at right angle to the wind direction.

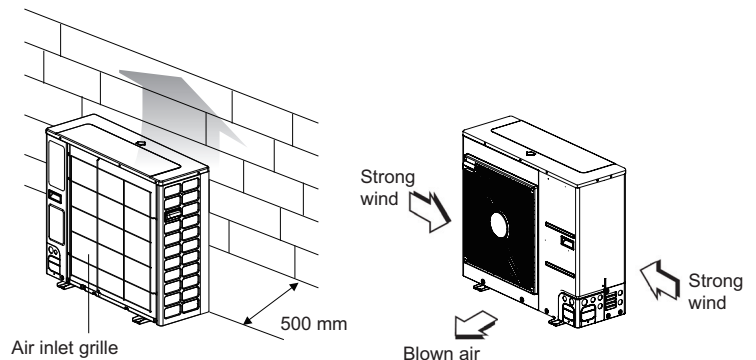

Turn the air outlet side toward the building's wall, fence or windbreak screen.

Set the outlet side at a right angle to the direction of the wind.

※ Outdoor unit is representative. Actual appearance of outdoor unit may be different but clearances will stay the same.

## 4. Water Control

### 4.1 Water quality

Water quality should be complied with EN 98/83 EC Directives.

#### CAUTION

- If the product is installed at existing hydraulic water loop, it is important to clean hydraulic pipes to remove sludge and scale.
- Installing sludge strainer in the water loop is very important to prevent performance degrade.
- Chemical treatment to prevent rust should be performed by installer.
- It is strongly recommended to install an additional filter on the heating water circuit. Especially to remove metallic particles from the heating piping, it is advised to use a magnetic or cyclone filter, which can remove small particles. Small particles may damage the unit and will NOT be removed by the standard filter of the heat pump system.
- Water quality check should be implemented before completing the installation of system.  
Detailed guide can be found in the table as below.

Water contents	Value			
pH	7.5~9.0			
Conductivity	10~500 uS/cm			
TDS (Total dissolved solids)	8~400 ppm			
Alkalinity (HCO <sub>3</sub> <sup>-</sup> )	60~300 (mg/L)			
Total hardness	4 ~ 8.5 °dH			
	71.4 ~ 151.7 (mg/L)			
Iron (Fe)	≤ 0.2 (mg/L)			
Sulphate (SO <sub>4</sub> <sup>2-</sup> )	≤ 100 (mg/L)			
Nitrite (NO <sub>3</sub> <sup>-</sup> )	≤ 100 (mg/L)			
Free chlorine (Cl <sub>2</sub> )	≤ 1 (mg/L)			
Chlorides (Cl <sup>-</sup> )	ppm		STS316	STS304
	pH7	15 °C	3,000	180
		40 °C	500	50
		60 °C	200	30
		80 °C	125	20
	pH9	15 °C	18,000	700
		40 °C	2,600	250
		60 °C	1,000	170
80 °C		550	130	



## 4. Water Control

### 4.2 Frost protection

In areas of the country where entering water temperatures drop below 0 °C, the water pipe must be protected by using an approved antifreeze solution. Consult your heat pump unit supplier for locally approved solutions in your area.

Calculate the approximate volume of water in the system. And add the water volume contained in the heat pump to this total volume.

Antifreeze type	Antifreeze mixing ratio (by volume)					
	0°C	-5°C	-10°C	-15°C	-20°C	-25°C
Methanol	0%	6%	12%	16%	24%	30%
Ethylene glycol	0%	12%	20%	30%	-	-
Propylene glycol	0%	17%	25%	33%	-	-

#### CAUTION

- Use only one of the above antifreeze.
- If a antifreeze is used, pressure drop and capability degradation of the system can be occurred.
- If one of antifreezes is used, corrosion can be occurred. So please add corrosion inhibitor.
- Please check the concentration of the antifreeze periodically to keep same concentration.
- When the antifreeze is used (for installation or operation), take care to ensure that antifreeze must not be touched.
- Ensure to respect all laws and norms of your country about antifreeze usage.

## 4. Water Control

### 4.3 Capacity correction factor by antifreeze

Antifreeze Type	Item	Antifreeze % by wt				
		10%	20%	30%	40%	50%
Methanol	Cooling	0.998	0.997	0.995	0.993	0.992
	Heating	0.995	0.990	0.985	0.979	0.974
	Pressure Drop	1.023	1.057	1.091	1.122	1.160
Ethylene glycol	Cooling	0.996	0.991	0.987	0.983	0.979
	Heating	0.993	0.985	0.977	0.969	0.961
	Pressure Drop	1.024	1.068	1.124	1.188	1.263
Propylene glycol	Cooling	0.993	0.987	0.980	0.974	0.968
	Heating	0.966	0.973	0.960	0.948	0.935
	Pressure Drop	1.040	1.098	1.174	1.273	1.405

#### ◆ Correction factor of cooling capacity

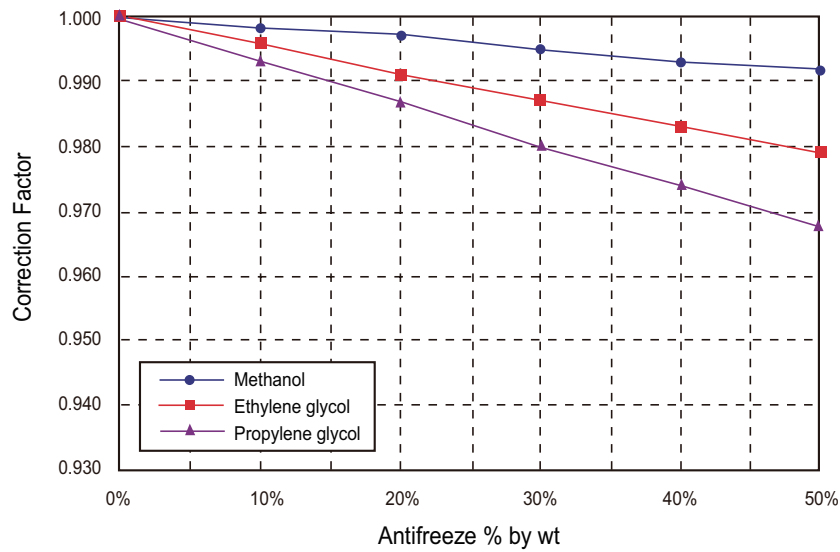

#### ◆ Correction factor of heating capacity

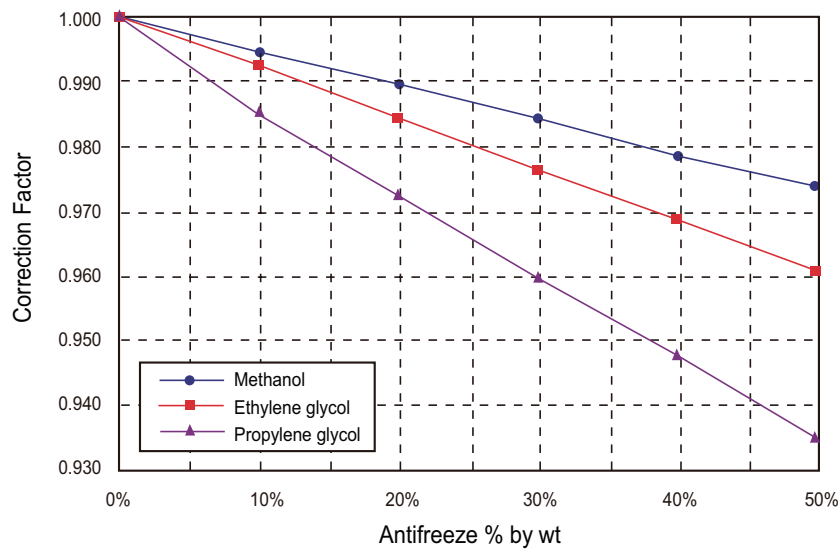

## 5. Dip Switch Setting

### 5.1 Information







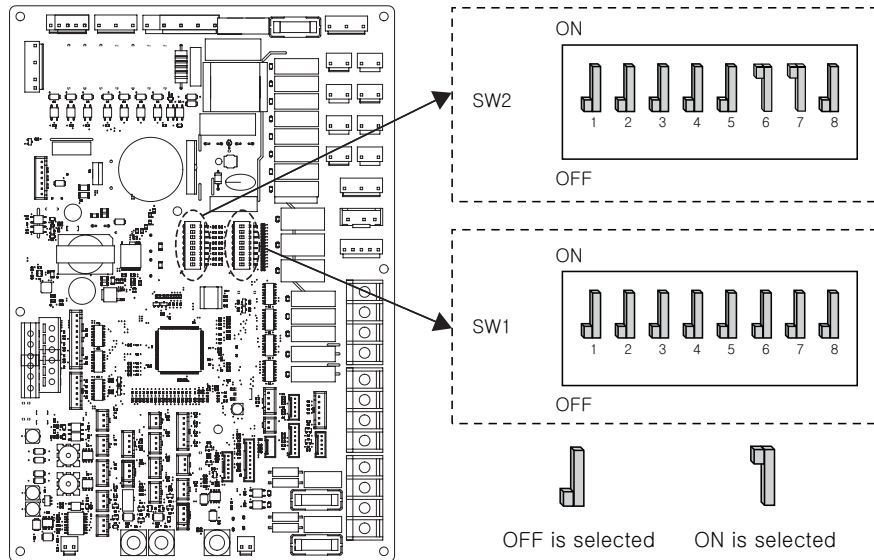

Turn off electric power supply before setting DIP switch

- Whenever adjusting DIP switch, turn off electric power supply to avoid electric shock.

#### ■ Indoor PCB (for Hydro Box Type)



#### ◆ Dip switch SW1

































Description	Setting	Default
MODBUS Communication Type	1  As Master (LG extension modules)	1 
	1  As Slave (3rd party controller)	
MODBUS Function	2  REGINE	2 
	2  Unified Open Protocol	
ANTIFREEZE	8  Antifreeze agent is not used	8 
	8  Antifreeze agent in used*	

\* Possibility to allow colder water temperature by setting.

Bridge at CN\_FLOW2 on Hydro-PCB must be dis-connected to enable setting.

## 5. Dip Switch Setting

### ◆ Dip switch SW2

Description	Setting	Default
Group control	1  As Master	1 
	1  As Slave	
Accessory installation information	  Heat pump is installed (Heating(Cooling) circuit only)	2  3 
	  Heat pump + DHW tank is installed	
	  Heat pump + DHW tank + Solar thermal system is installed	
	  Unused	
Cycle	4  Heating Only	4 
	4  Heating & Cooling	
Room Air Sensor	5  Room Air Sensor is not installed	5 
	5  Room Air Sensor is installed	
Selecting Backup Heater capacity	  Electric Heater is not used	6  7 
	  Half capacity is used	
	  Unused	
	  Full capacity is used	
Thermostat installation information	8  Thermostat is NOT installed	8 
	8  Thermostat is installed	

# 5. Dip Switch Setting

## Indoor PCB (for IWT)

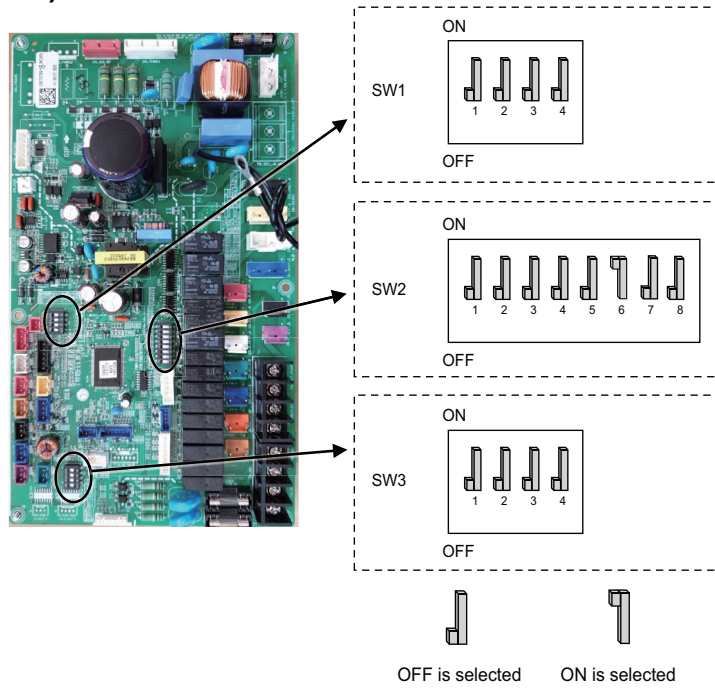

### ◆ Dip switch SW1

Description	Setting	Default	
MODBUS Communication Type	1	As Master (LG extension modules)	1
	1	As Slave (3rd party controller)	
Unused	2  2	Unused	2
Unused	3  3	Unused	3
Unused	4  4	Unused	4



























### ◆ Dip switch SW3

Description	Setting	Default	
Remote Room air sensor (Accessory)	1	Remote sensor is not installed	1
	1	Remote sensor is installed	
Antifreeze agent	2	Antifreeze agent is not used	2
	2	Antifreeze agent is used *	
Unused	3  3	Unused	3
Unused	4  4	Unused	4

\* Possibility to allow colder water temperature by setting.  
 Bridge at CN\_FLOW2 on Hydro-PCB must be dis-connected to enable setting.

## 5. Dip Switch Setting

### ◆ Dip switch SW2

Description	Setting	Default	
Group control	1  As Master	1 	
	1  As Slave		
Accessory installation information	  2 3	 	
	  2 3		Unit + Outdoor unit + DHW tank is installed
	  2 3		
Cycle	4  Heating Only	4 	
	4  Heating & Cooling		
Selecting Electric Heater operation	  6 7	 	
	  6 7		Electric heater is used
	  6 7		Unused
	  6 7		Unused
Thermostat installation information	8  Thermostat is NOT installed	8 	
	8  Thermostat is installed		

Dip-Switch SW2 no.5 have no function.

## 5. Dip Switch Setting

### Outdoor Unit

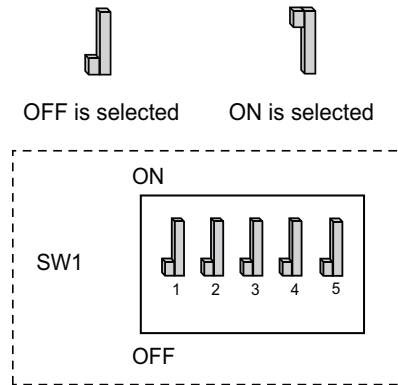
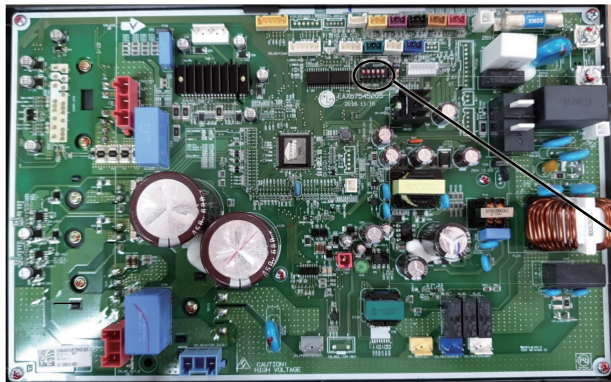

### ◆ Dip switch Information

Description	Setting			Default
Low Noise Mode	2	OFF	Always Mode : Maintain Low noise mode for target temperature	OFF
		ON	Partial mode : Escape Low noise mode for target temperature	
Peak Control	3	OFF	Max Mode	
		ON	Peak Control : To limit maximum current (Power saving)	

- Only DIP-switch no. 2 and no.3 has a function. Others have no function.
- When setting the Partial mode, mode can be exited to secure capacity after operating for a certain time.



**Air Solution**

LG Electronics Inc, 128, Yeoui-daero,  
Yeongdeungpo-gu, Seoul, Korea  
(07336)  
<http://partner.lge.com>

Copyright © 2019-2021 LG Electronics Inc.  
All Rights Reserved.  
Printed in Korea November / 2021

The air conditioners manufactured by LG have received ISO9001 certificate for quality assurance and ISO14001 certificate for environmental management system.  
The specifications, designs, and information in this brochure are subject to change without notice.